

Roland

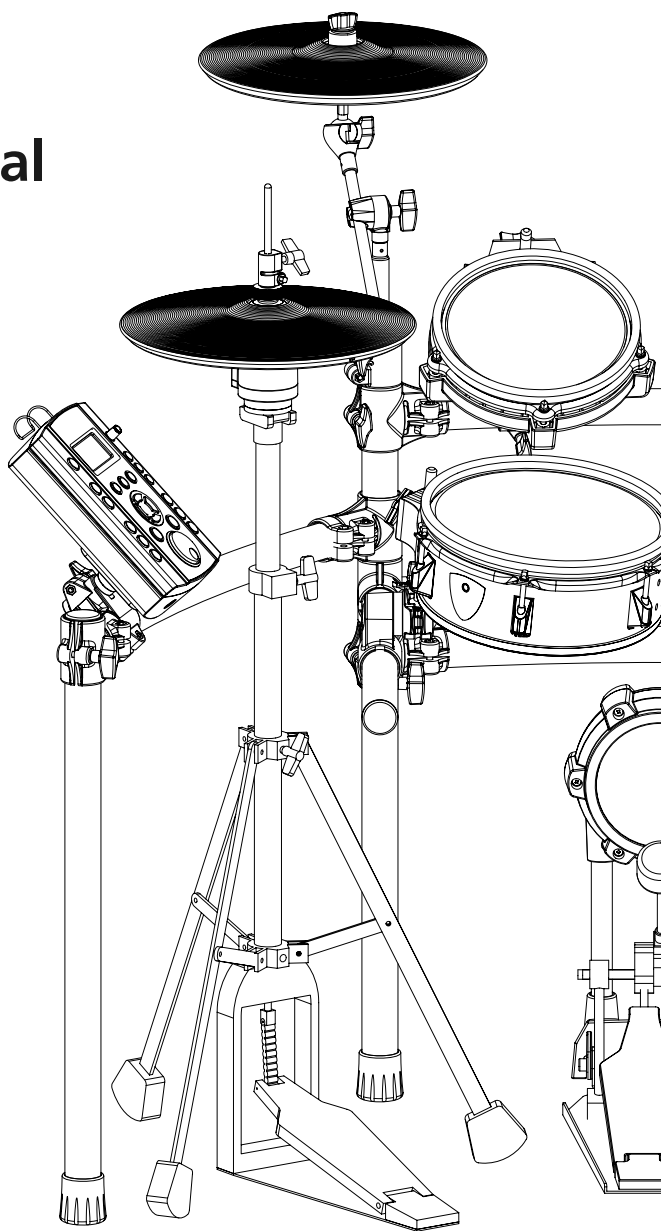

TD-9 Owner's Manual



For the U.K.

IMPORTANT: THE WIRES IN THIS MAINS LEAD ARE COLOURED IN ACCORDANCE WITH THE FOLLOWING CODE.

BLUE: NEUTRAL
BROWN: LIVE

As the colours of the wires in the mains lead of this apparatus may not correspond with the coloured markings identifying the terminals in your plug, proceed as follows:

The wire which is coloured BLUE must be connected to the terminal which is marked with the letter N or coloured BLACK.
The wire which is coloured BROWN must be connected to the terminal which is marked with the letter L or coloured RED.
Under no circumstances must either of the above wires be connected to the earth terminal of a three pin plug.

For EU Countries



This product complies with the requirements of EMC Directive 2004/108/EC.

For the USA

FEDERAL COMMUNICATIONS COMMISSION RADIO FREQUENCY INTERFERENCE STATEMENT

This equipment has been tested and found to comply with the limits for a Class B digital device, pursuant to Part 15 of the FCC Rules. These limits are designed to provide reasonable protection against harmful interference in a residential installation. This equipment generates, uses, and can radiate radio frequency energy and, if not installed and used in accordance with the instructions, may cause harmful interference to radio communications. However, there is no guarantee that interference will not occur in a particular installation. If this equipment does cause harmful interference to radio or television reception, which can be determined by turning the equipment off and on, the user is encouraged to try to correct the interference by one or more of the following measures:

- Reorient or relocate the receiving antenna.
- Increase the separation between the equipment and receiver.
- Connect the equipment into an outlet on a circuit different from that to which the receiver is connected.
- Consult the dealer or an experienced radio/TV technician for help.

This device complies with Part 15 of the FCC Rules. Operation is subject to the following two conditions:

- (1) this device may not cause harmful interference, and
- (2) this device must accept any interference received, including interference that may cause undesired operation.

This equipment requires shielded interface cables in order to meet FCC class B limit.

Any unauthorized changes or modifications not expressly approved by the party responsible for compliance could void the user's authority to operate the equipment.

For Canada

NOTICE

This Class B digital apparatus meets all requirements of the Canadian Interference-Causing Equipment Regulations.

AVIS

Cet appareil numérique de la classe B respecte toutes les exigences du Règlement sur le matériel brouilleur du Canada.

For C.A. US (Proposition 65)

WARNING

This product contains chemicals known to cause cancer, birth defects and other reproductive harm, including lead.

Thank you, and congratulations on your choice of the Roland Percussion Sound Module TD-9.

Before using this unit, carefully read the sections entitled: "USING THE UNIT SAFELY" and "IMPORTANT NOTES" (Owner's manual p. 4-5; p. 6-7). These sections provide important information concerning the proper operation of the unit. Additionally, in order to feel assured that you have gained a good grasp of every feature provided by your new unit, Quick start and Owner's manual should be read in its entirety.

The manual should be saved and kept on hand as a convenient reference.

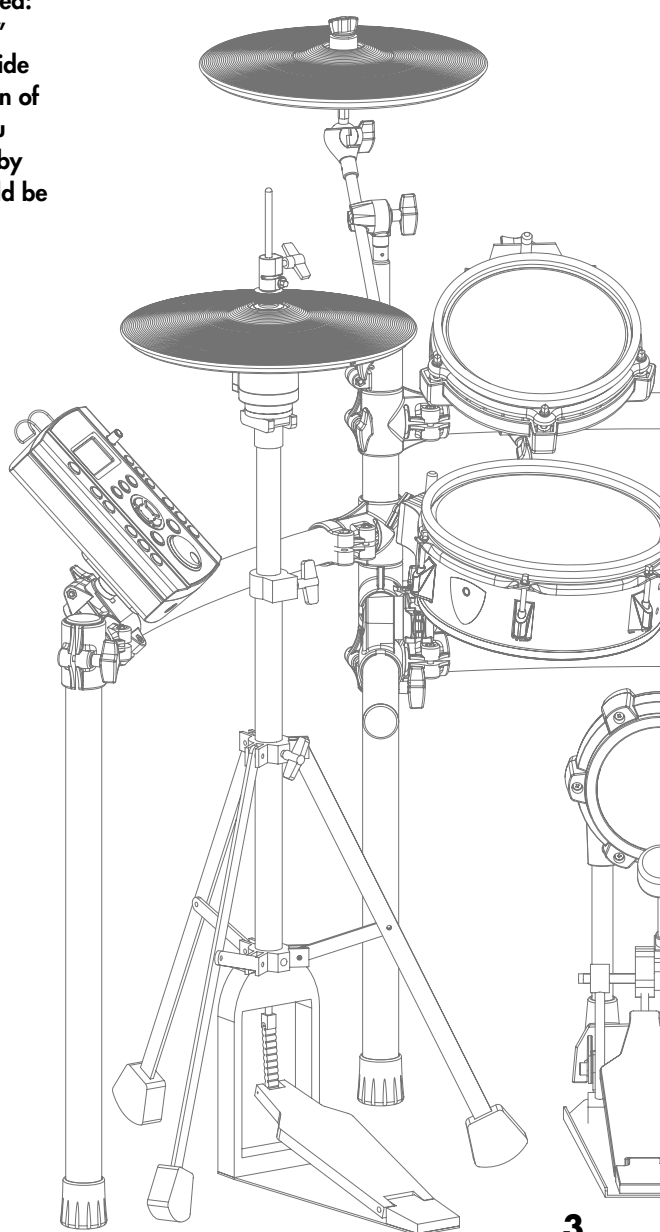

Copyright © 2010 ROLAND CORPORATION

All rights reserved. No part of this publication may be reproduced in any form without the written permission of ROLAND CORPORATION.

Roland is a registered trademark of Roland Corporation in the United States and/or other countries.

USING THE UNIT SAFELY

INSTRUCTIONS FOR THE PREVENTION OF FIRE, ELECTRIC SHOCK, OR INJURY TO PERSONS

About ⚠ WARNING and ⚠ CAUTION Notices

⚠ WARNING	Used for instructions intended to alert the user to the risk of death or severe injury should the unit be used improperly.
⚠ CAUTION	Used for instructions intended to alert the user to the risk of injury or material damage should the unit be used improperly. * Material damage refers to damage or other adverse effects caused with respect to the home and all its furnishings, as well to domestic animals or pets.

About the Symbols

	The ⚠ symbol alerts the user to important instructions or warnings. The specific meaning of the symbol is determined by the design contained within the triangle. In the case of the symbol at left, it is used for general cautions, warnings, or alerts to danger.
	The ⚡ symbol alerts the user to items that must never be carried out (are forbidden). The specific thing that must not be done is indicated by the design contained within the circle. In the case of the symbol at left, it means that the unit must never be disassembled.
	The ⚡ symbol alerts the user to things that must be carried out. The specific thing that must be done is indicated by the design contained within the circle. In the case of the symbol at left, it means that the power-cord plug must be unplugged from the outlet.

ALWAYS OBSERVE THE FOLLOWING

⚠ WARNING

- Do not open (or modify in any way) the unit or its AC adaptor.
- Do not attempt to repair the unit, or replace parts within it (except when this manual provides specific instructions directing you to do so). Refer all servicing to your retailer, the nearest Roland Service Center, or an authorized Roland distributor, as listed on the "Information" page.
- Never use or store the unit in places that are:
 - Subject to temperature extremes (e.g., direct sunlight in an enclosed vehicle, near a heating duct, on top of heat-generating equipment); or are
 - Damp (e.g., baths, washrooms, on wet floors); or are
 - Humid; or are
 - Exposed to rain; or are
 - Dusty; or are
 - Subject to high levels of vibration.
- This unit should be used only with a rack or stand that is recommended by Roland.
- When using the unit with a rack or stand recommended by Roland, the rack or stand must be carefully placed so it is level and sure to remain stable. If not using a rack or stand, you still need to make sure that any location you choose for placing the unit provides a level surface that will properly support the unit, and keep it from wobbling.

⚠ WARNING

- Be sure to use only the AC adaptor supplied with the unit. Also, make sure the line voltage at the installation matches the input voltage specified on the AC adaptor's body. Other AC adaptors may use a different polarity, or be designed for a different voltage, so their use could result in damage, malfunction, or electric shock.
- Use only the attached power-supply cord. Also, the supplied power cord must not be used with any other device.
- Do not excessively twist or bend the power cord, nor place heavy objects on it. Doing so can damage the cord, producing severed elements and short circuits. Damaged cords are fire and shock hazards!
- This unit, either alone or in combination with an amplifier and headphones or speakers, may be capable of producing sound levels that could cause permanent hearing loss. Do not operate for a long period of time at a high volume level, or at a level that is uncomfortable. If you experience any hearing loss or ringing in the ears, you should immediately stop using the unit, and consult an audiologist.
- Do not allow any objects (e.g., flammable material, coins, pins); or liquids of any kind (water, soft drinks, etc.) to penetrate the unit.

WARNING

- Immediately turn the power off, remove the AC adaptor from the outlet, and request servicing by your retailer, the nearest Roland Service Center, or an authorized Roland distributor, as listed on the "Information" page when:
 - The AC adaptor, the power-supply cord, or the plug has been damaged; or
 - If smoke or unusual odor occurs
 - Objects have fallen into, or liquid has been spilled onto the unit; or
 - The unit has been exposed to rain (or otherwise has become wet); or
 - The unit does not appear to operate normally or exhibits a marked change in performance.
- In households with small children, an adult should provide supervision until the child is capable of following all the rules essential for the safe operation of the unit.
- Protect the unit from strong impact. (Do not drop it!)
- Do not force the unit's power-supply cord to share an outlet with an unreasonable number of other devices. Be especially careful when using extension cords—the total power used by all devices you have connected to the extension cord's outlet must never exceed the power rating (watts/amperes) for the extension cord. Excessive loads can cause the insulation on the cord to heat up and eventually melt through.
- Before using the unit in a foreign country, consult with your retailer, the nearest Roland Service Center, or an authorized Roland distributor, as listed on the "Information" page.

CAUTION

- The unit and the AC adaptor should be located so their location or position does not interfere with their proper ventilation.
- This (TD-9) for use only with Roland stand MDS series. Use with other stands is capable of resulting in instability causing possible injury.
- Always grasp only the plug on the AC adaptor cord when plugging into, or unplugging from, an outlet or this unit.
- At regular intervals, you should unplug the AC adaptor and clean it by using a dry cloth to wipe all dust and other accumulations away from its prongs. Also, disconnect the power plug from the power outlet whenever the unit is to remain unused for an extended period of time. Any accumulation of dust between the power plug and the power outlet can result in poor insulation and lead to fire.
- Try to prevent cords and cables from becoming entangled. Also, all cords and cables should be placed so they are out of the reach of children.
- Never climb on top of, nor place heavy objects on the unit.
- Never handle the AC adaptor or its plugs with wet hands when plugging into, or unplugging from, an outlet or this unit.
- Before moving the unit, disconnect the AC adaptor and all cords coming from external devices.
- Before cleaning the unit, turn off the power and unplug the AC adaptor from the outlet.
- Whenever you suspect the possibility of lightning in your area, disconnect the AC adaptor from the outlet.
- Keep any caps you may remove and the included wing bolts in a safe place out of children's reach, so there is no chance of them being swallowed accidentally.

IMPORTANT NOTES

Power Supply

- Do not connect this unit to same electrical outlet that is being used by an electrical appliance that is controlled by an inverter (such as a refrigerator, washing machine, microwave oven, or air conditioner), or that contains a motor. Depending on the way in which the electrical appliance is used, power supply noise may cause this unit to malfunction or may produce audible noise. If it is not practical to use a separate electrical outlet, connect a power supply noise filter between this unit and the electrical outlet.
- The AC adaptor will begin to generate heat after long hours of consecutive use. This is normal, and is not a cause for concern.
- Before connecting this unit to other devices, turn off the power to all units. This will help prevent malfunctions and/or damage to speakers or other devices.

Placement

- Using the unit near power amplifiers (or other equipment containing large power transformers) may induce hum. To alleviate the problem, change the orientation of this unit; or move it farther away from the source of interference.
- This device may interfere with radio and television reception. Do not use this device in the vicinity of such receivers.
- Noise may be produced if wireless communications devices, such as cell phones, are operated in the vicinity of this unit. Such noise could occur when receiving or initiating a call, or while conversing. Should you experience such problems, you should relocate such wireless devices so they are at a greater distance from this unit, or switch them off.
- Do not expose the unit to direct sunlight, place it near devices that radiate heat, leave it inside an enclosed vehicle, or otherwise subject it to temperature extremes. Excessive heat can deform or discolor the unit.
- When moved from one location to another where the temperature and/or humidity is very different, water droplets (condensation) may form inside the unit. Damage or malfunction may result if you attempt to use the unit in this condition. Therefore, before using the unit, you must allow it to stand for several hours, until the condensation has completely evaporated.

Maintenance

- For everyday cleaning wipe the unit with a soft, dry cloth or one that has been slightly dampened with water. To remove stubborn dirt, use a cloth impregnated with a mild, non-abrasive detergent. Afterwards, be sure to wipe the unit thoroughly with a soft, dry cloth.
- Never use benzene, thinners, alcohol or solvents of any kind, to avoid the possibility of discoloration and/or deformation.

Repairs and Data

- Please be aware that all data contained in the unit's memory may be lost when the unit is sent for repairs. Important data should always be backed up on a USB memory key, or written down on paper (when possible). During repairs, due care is taken to avoid the loss of data. However, in certain cases (such as when circuitry related to memory itself is out of order), we regret that it may not be possible to restore the data, and Roland assumes no liability concerning such loss of data.

Additional Precautions

- Please be aware that the contents of memory can be irretrievably lost as a result of a malfunction, or the improper operation of the unit. To protect yourself against the risk of losing important data, we recommend that you periodically save a backup copy of important data you have stored in the unit's memory on a USB memory key.
- Unfortunately, it may be impossible to restore the contents of data that was stored on a USB memory key once it has been lost. Roland Corporation assumes no liability concerning such loss of data.
- Use a reasonable amount of care when using the unit's buttons, sliders, or other controls; and when using its jacks and connectors. Rough handling can lead to malfunctions.
- Never strike or apply strong pressure to the display.
- When connecting / disconnecting all cables, grasp the connector itself—never pull on the cable. This way you will avoid causing shorts, or damage to the cable's internal elements.
- To avoid disturbing your neighbors, try to keep the unit's volume at reasonable levels. You may prefer to use headphones, so you do not need to be concerned about those around you (especially when it is late at night).

- Since sound vibrations can be transmitted through floors and walls to a greater degree than expected, take care not to allow such sound to become a nuisance to neighbors, especially at night and when using headphones. Although the drum pads and pedals are designed so there is a minimal amount of extraneous sound produced when they're struck, rubber heads tend to produce louder sounds compared to mesh heads. You can effectively reduce much of the unwanted sound from the pads by switching to mesh heads.
- When you need to transport the unit, package it in the box (including padding) that it came in, if possible. Otherwise, you will need to use equivalent packaging materials.
- Some connection cables contain resistors. Do not use cables that incorporate resistors for connecting to this unit. The use of such cables can cause the sound level to be extremely low, or impossible to hear. For information on cable specifications, contact the manufacturer of the cable.

-
- MMP (Moore Microprocessor Portfolio) refers to a patent portfolio concerned with microprocessor architecture, which was developed by Technology Properties Limited (TPL). Roland has licensed this technology from the TPL Group.
 - MatrixQuest™ 2007 TEPCO UQUEST, LTD. All rights reserved. The TD-9's USB functionality uses Matrix-Quest middleware technology from TEPCO UQUEST, LTD.



- Fugue © 1999-2010 Kyoto Software Research, Inc. All rights reserved.
 - All product names mentioned in this document are trademarks or registered trademarks of their respective owners.
-

Using USB Memory Key

- Use USB memory key sold by Roland! We cannot guarantee operation if other products are used.
- Carefully insert the USB memory key all the way in—until it is firmly in place.

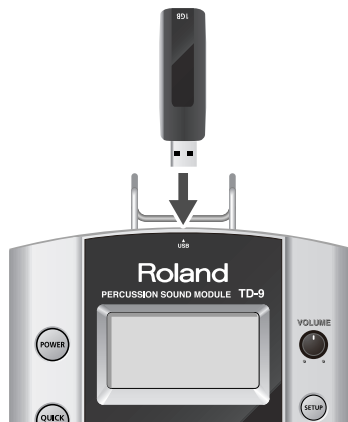

- Never touch the terminals of the USB memory key. Also, avoid getting the terminals dirty.
- USB memory key are constructed using precision components; handle the cards carefully, paying particular note to the following.
 - To prevent damage to the cards from static electricity, be sure to discharge any static electricity from your own body before handling the cards.
 - Do not touch or allow metal to come into contact with the contact portion of the cards.
 - Do not bend, drop, or subject cards to strong shock or vibration.
 - Do not keep cards in direct sunlight, in closed vehicles, or other such locations.
 - Do not allow cards to become wet.
 - Do not disassemble or modify the cards.
- Do not unplug USB memory key from the TD-9 while the USB memory access indicator is blinking. Doing so may damage the USB memory key or the data.
- Do not connect any device other than USB memory key to the USB memory connector.

Some USB memory keys might have a vibration noise when playing with TD-9.

In that case, it would be better to fix up the USB memory key with a rubber band, or change it to some Non-Slide type one, to get rid of the noise.

Contents

USING THE UNIT SAFELY	4
IMPORTANT NOTES	6

1. Introduction 11

TD-9 Components	12
Top and rear panels	12
Jack panel	13
Basic concepts and operations of the TD-9	14
Saving your settings	14
Buttons, dial, and knobs	14
Cursor	14
Function buttons ([F1]–[F3])	14
Using the “+” button, “-” button, and VALUE dial	14
Preview function	15
Song playback	15
Using the Metronome	15
Setting the Tempo (for the metronome or song)	15
Adjusting the display contrast	15
The upper right of the display	15
Getting ready to play	16
Mounting the TD-9 on the Stand	16
Connecting your audio equipment	17
Turning the power on/off	18
Tensioning the pads	19
Tensioning the head of a mesh pad	19

2. Performing 21

Selecting a drum kit	22
Selecting a drum kit	22
About the “DRUM KIT” screen	22
Activating the cross stick function	22
Performance techniques	23
Pads (e.g., PD-105/PD-85)	23
Cymbals (e.g., CY-8, CY-13R)	23
Choking a cymbal	24
Hi-Hat (CY-5, VH-11)	24
Creating a drum kit	25
Selecting an instrument	25

Editing instrument parameters	25
Using the Mixer (MIXER).....	27
Using the onboard effects (AMB/EQ).....	28
Adjusting the ambience for each pad (SEND)	28
Naming a drum kit	29
Copying a drum kit or instrument.....	29
Settings that are copied	29
Copying a drum kit	30
Copying an instrument.....	31
MIDI parameters for each pad & pedal.....	32

3. Playing along with music 33

Playing with the internal songs or from a USB memory key 34

Song Function profile	34
Audio files that can be played by the TD-9	34
Connecting USB memory key	34
Song selection	35
What's in "SONG" screen.....	35
Playing a song	35
Selecting a song from USB memory key	35
Setting the tempo	36
Muting a part.....	36
Muting the drum part.....	36
Viewing song information / Editing song settings	37
Using the Repeat function (Repeat)	37

Using the MIX IN 38

Connections.....	38
Playback	38

4. Practicing 39

On Board Metronome 40

Using the metronome	40
Metronome parameters	40
Changing the tempo (TEMPO)	40
Changing the metronomes sound (CLICK INST).....	40
Changing the time signature (TIME SIGNATURE)	40

Quick recording and playback (QUICK REC / QUICK PLAY) 41

QUICK REC	41
Recording and playing your performance	41
Recording together with a song	41
Playback	42

Using the Scope function (SCOPE) 43

Viewing the SCOPE screen.....	43
-------------------------------	----

5. Advanced applications 45

Optimizing the pad settings (Trigger parameters)	46
Specifying the type of pad [F1] (TYPE)	46
Dual trigger support for each pad	46
Setting the Pad Sensitivity [F2] (BASIC)	47
Detailed settings for trigger parameters [F3] (ADVNCND)	48
[F1] (SCAN)	48
[F2] (RIM)	49
[F3] (HI-HAT)	49
Connecting the VH-11 and making settings on the TD-9	50
If the Clutch Was Apart from the Hi-Hat	51
Hi-Hat Being Properly Assembled	51
MIDI-related settings	52
MIDI settings for the entire TD-9 [F1] (GLOBAL)	52
MIDI settings for precise expressiveness in performances [F2] (CTRL)	54
Editing a percussion set [F3] (PERC)	55
Editing the Percussion Set	55
Individual Percussion Instrument Parameters	55
Other settings (Utility)	56
Overall settings for the TD-9 [F1] (UTILITY)	56
Using a pad as a switch (Pad Switch)	56
Adjusting the display contrast (LCD Contrast)	56
Setting the preview velocity (Preview Velocity)	56
Using USB memory [F2] (USB)	57
Saving data to a USB memory key (SAVE)	57
Loading data from a USB memory key back into the TD-9 (LOAD)	59
Deleting data from a USB memory key / Formatting a USB memory key (DL/FMT)	60
Restoring the factory settings [F3] (RESET)	61

6. Appendices 63

Error Messages	64
Preset Drum Kit List	65
Preset Song List	66
Drum Instrument List	67
Preset Percussion Set List	71
MIDI Implementation Chart	72
Specifications	73
Block Diagram	74
Index	76

1. Introduction



TD-9 Components

Top and rear panels

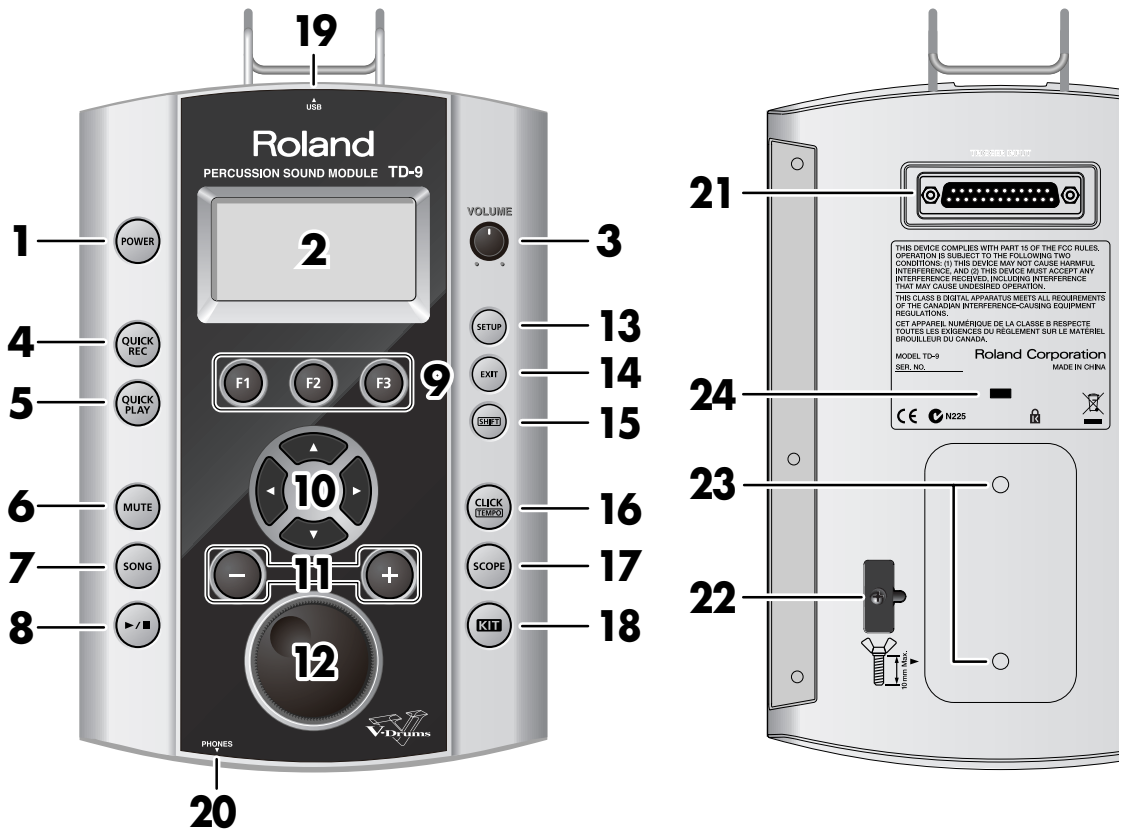

1. **POWER button**
Turns the power on/off.
2. **Display**
This shows the drum kit name in “normal” playing mode, or if you select Edit, Song etc, various graphic/text displays will appear.
3. **VOLUME knob**
Adjusts the volume from the OUTPUT and PHONES jacks.
4. **QUICK REC button**
Use this to record your playing.
5. **QUICK PLAY button**
Play back what you recorded.
6. **MUTE button**
When a song is playing back, use this button to mute (silence) the drum part.
7. **SONG button**
Press this to play back a song or access song-related settings. The “SONG” screen appears.
8. **[▶/■] button**
Press to play back or stop a song.
9. **F1–F3 buttons (function buttons)**
The functions of these buttons will change depending on the screen that is displayed.
The function name for each button is displayed at the bottom of the screen.
10. **Cursor buttons (◀ / ▶ / ▲ / ▼)**
Use these buttons to move the cursor in the screen.
Also used as function buttons when selecting a pad or playing back a song.

11. + button, - button

Use these buttons to switch drum kits or to edit a value. Pressing the "+" button increases the value, and pressing the "-" button decreases it.

12. VALUE dial

This dial has the same function as the "+" and "-" buttons. Use the dial when you want to quickly change the drum kit or value in large steps.

13. SETUP button

Use this button to make settings that affect the entire TD-9, such as MIDI, triggering, pad sensitivity etc.

14. EXIT button

Each time you press this button, you return to the screen of the previous level. Pressing it several times will take you to the "DRUM KIT" screen.

15. SHIFT button

Used in conjunction with other buttons. When holding it down, the functions of other buttons will change.

16. CLICK (TEMPO) button

This starts the Metronome. Holding this button while holding down the SHIFT button, you can edit various parameters related to tempo and click. (sound etc)

17. SCOPE button

This activates the Scope function, allowing you to view your timing on the screen.

18. KIT button

Press this to access the basic KIT screen, (p. 22) ideal when just playing the TD-9.

19. USB memory slot

For connecting USB memory key (sold separately).

20. PHONES jack

For connecting stereo headphones. Using the headphone jack will not mute the main OUTPUT jacks.

21. TRIGGER INPUT connector

Connecting the special cable connects the pads and pedals to the TD-9.

22. Cable hook

Used to secure the AC adaptor cable.

23. Sound module mounting plate attachment holes

Attach the included sound module mounting plate here so that you can attach the TD-9 to your drum stand.

24. Security Slot ()

<http://www.kensington.com/>

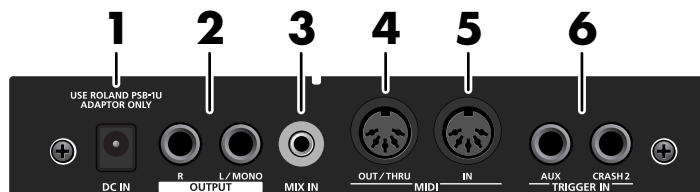
Jack panel**1. DC IN jack**

Connect the included AC adaptor here.

2. OUTPUT jacks (L/MONO, R)

All sounds of the TD-9 are output here. Use for connecting to an amp or other external audio equipment. If you're working in mono, only use the L/MONO jack.

3. MIX IN jack

For connecting an external audio source such as MP3 or CD players. All sound input here is also sent from the OUTPUT and PHONES jacks.

* To adjust the volume, use the controls of the external device connected to MIX IN.

4. MIDI OUT/THRU connector

Use this when you want to use the pads to play external MIDI sound sources or for recording with sequencers (p. 46).

5. MIDI IN connector

Use this for triggering sounds in the TD-9 via a MIDI sequencer or pad controller (p. 46).

6. TRIGGER IN jacks (AUX, CRASH2)

Use these jacks to add more pads.

Basic concepts and operations of the TD-9

This section explains operations that are common to all of the TD-9's functionality.

Saving your settings

The TD-9 has no "Save" function to save your settings. Any changes you make will be saved when you turn off the power.

- * Be sure to turn off the power by pressing the POWER button (p. 18).

Buttons, dial, and knobs

In this manual, references to the panel buttons, knobs and dial are enclosed in square brackets []; e.g., [SETUP].

Cursor

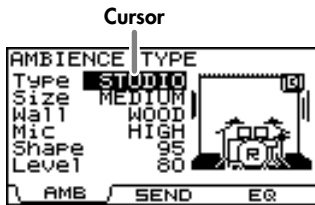

The cursor is the highlighted text in the screen that indicates what you can edit.

If there is more than one editable item in a screen, you can use the [CURSOR] buttons to move the cursor to the item you want to edit.



Function buttons ([F1]–[F3])



The [F1]–[F3] buttons are called "function buttons." The bottom line of the display indicates the name of the functions performed by [F1]–[F3].

For example if an explanation in this manual refers to [KIT]-[F2] (FUNC), this means that you should press [KIT] and then [F2] (in this case, there will be an indication of "FUNC" above the [F2] button).

Using the "+" button, "-" button, and VALUE dial

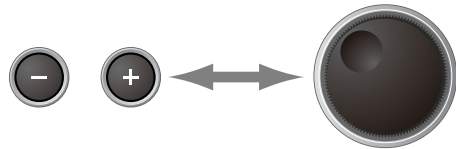

The [+] and [-] buttons (referred to as [+/-] in this manual) and VALUE dial (referred to as [VALUE]) are both used to edit settings.

When this manual tells you to "use [+/-]," you can also use [VALUE] to get the same result. Each method has the following characteristics.

[+/-]

- The value of the setting will increase each time you press [+], and decrease each time you press [-]. This is convenient when you want to make fine adjustments.
- When making an on/off setting, press [+] to turn it on or press [-] to turn it off.
- Shortcut: The value will increase rapidly if you hold down [+] and press [-], or decrease rapidly if you hold down [-] and press [+].
- The value will change in larger steps if you press [+/-] while holding down [SHIFT].

[VALUE] dial

This dial lets you make large changes in a value easily. Convenient for working with parameters that have broad value range.

- If you turn the [VALUE] dial while holding down [SHIFT], the value will change more rapidly.

Preview function

By holding down [SHIFT] and pressing [KIT], you can audition a sound.

To set the preview velocity, use [SETUP]-[F3] (UTIL)-[F1] (UTIL) (p. 56).



Song playback

When you press [SONG], the "Song" screen appears.

You can select a song using the [+/-] buttons or turning the [VALUE] dial.



Press [▶/■] to play back the song.

Press again [▶/■] to stop it.



Using the Metronome

To start the metronome, press [CLICK (TEMPO)] and the button lights up.

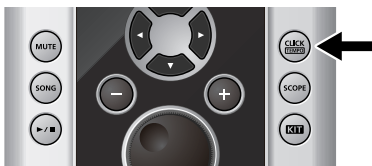

To turn it off, press [CLICK (TEMPO)] once again, and the button goes dark.

Setting the Tempo (for the metronome or song)

To adjust the tempo, hold down [SHIFT] and press [CLICK (TEMPO)] the tempo screen appears. Use the [+/-] buttons or [VALUE] to set the tempo.

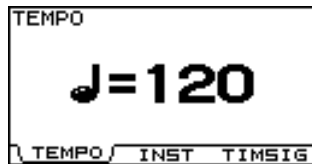

Adjusting the display contrast

The display's visibility can be affected by surrounding light and temperature. To adjust the contrast, **hold down [KIT] and turn [VALUE] to the desired setting.**

* Display contrast can also be adjusted by pressing [SETUP]-[F3] (UTIL)-[F1] (UTIL) (p. 56).

The upper right of the display

In the screens where you make adjustments for each pad, hitting any pad or pedal will access the edit screen for that pad. The name of the selected pad appears in the upper right of the display.



The "HEAD" or "RIM" indicator tells you whether the settings are for the head or the rim of that pad.

Getting ready to play

Mounting the TD-9 on the Stand

1. Attach the included sound module mounting plate to the TD-9.

Use the included wing bolts to attach the plate as shown in the illustration.

- * Use only the included wing bolts. Using any other nuts may cause malfunction.
- * You must use the TD-9 with the sound module mounting plate installed.

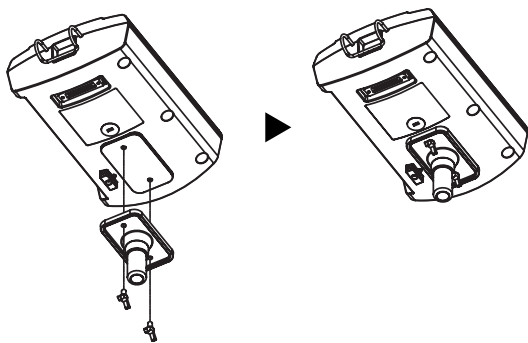

Labels indicating the pad to be connected are attached to the cable.

Connect the pads and pedals as shown in the illustration.

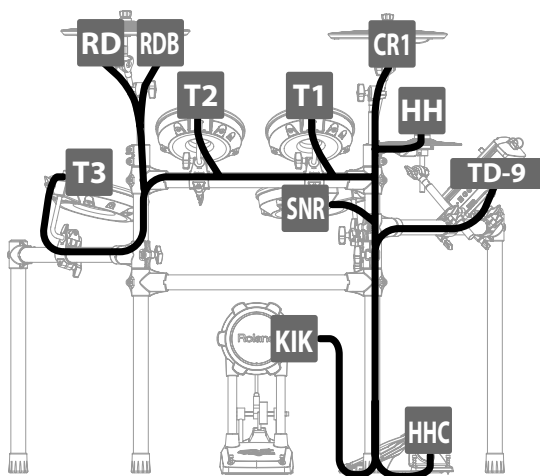
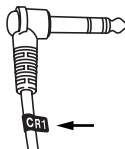

NOTE

- When turning the unit upside-down, get a bunch of newspapers or magazines, and place them under the four corners or at both ends to prevent damage to the buttons and controls. Also, you should try to orient the unit so no buttons or controls get damaged.
- When turning the unit upside-down, handle with care to avoid dropping it, or allowing it to fall or tip over.

NOTE

- If you don't connect a pad to each of the cables, make the following settings for unconnected pads in order to prevent malfunction.
 - Turn the instrument's Group setting OFF (p. 25).
 - In the pad's MIDI settings, turn the NOTE NUMBER setting OFF (p. 32).
- When using any other cymbal pads than CY-13R or CY-15R, no need to connect the "RDB" cable to the cymbal pad. Keeping the cap on top of the "RDB" cable plug, please fasten it up on the stand so that it does not disturb your playing.

2. Attach the TD-9 (with the sound module mounting plate installed) to your drum stand (such as the MDS-9; available separately).

3. Connect the included cable to the TD-9's TRIGGER INPUT connector, and connect your pads and pedals.



Connecting your audio equipment

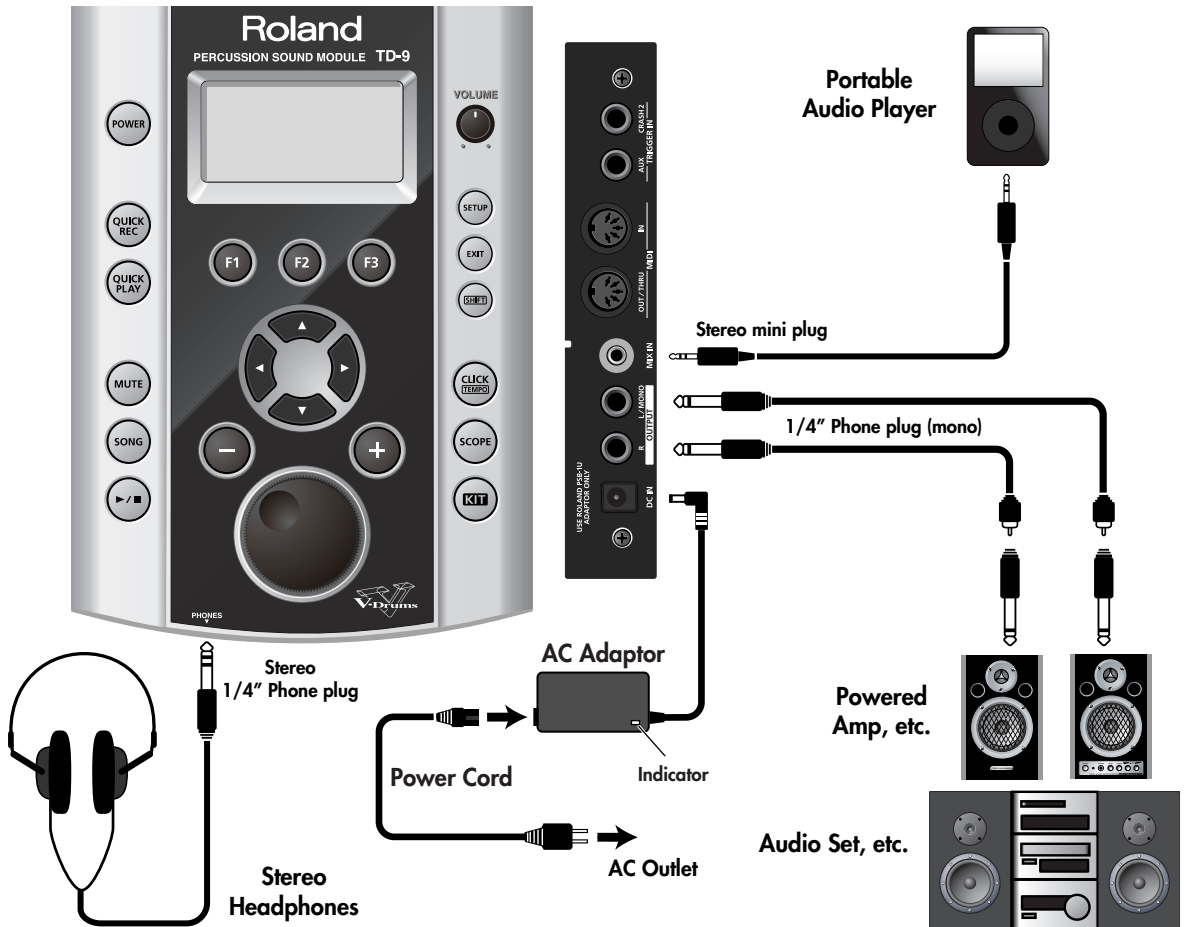

1. Power-off all equipment before making connections.

NOTE

To prevent malfunction and/or damage to speakers or other devices, always turn down the volume, and turn off the power on all devices before making connections.

2. Connect the **OUTPUT** jacks (L/MONO, R) to your audio system or amp. If you're using headphones, connect them to the **PHONES** jack.
3. Connect the included AC adaptor to the **DC IN** jack. Place the AC adaptor so the side with the indicator (see illustration) faces upwards and the side with written information faces downwards.

* The indicator will light when you plug the AC adaptor into an AC outlet.

* To prevent accidental disruption of power to the TD-9 (should the plug be pulled out accidentally), and to avoid applying undue stress to the AC adaptor jack, anchor the power cord using the cord hook, as shown in the illustration.

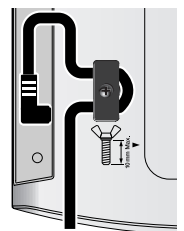

MEMO

Using the **MIX IN** jack allows playing along with music from a portable audio player or other external sources.

Turning the power on/off

* Once connections have been made (p. 17), turn on the power to the connected equipment in the order specified. Doing it in the wrong order raises the risk of damage/malfunction to that equipment.

1. Turn [VOLUME] all the way to the left.



2. Do the same with the connected amp or audio system.

3. Press [POWER].

After a time, [POWER] will light.

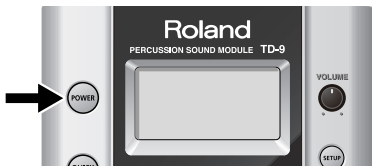

* The TD-9 is equipped with a protection circuit and requires a brief interval (a few seconds) after powering before it will operate normally.

Caution when turning on the power

After you turn on the power, do NOT touch any pads or pedals until the drum kit name (the illustration below) has appeared in the display. Doing so can cause various problems.



4. Power-on the connected amp or audio system.

5. While hitting a pad, gradually turn [VOLUME] toward the right to adjust the volume.

Adjust the volume of the connected amp/ audio system to the desired level.

If you don't hear any sound

Check the following points.

Pad and pedal connections

- Is the cable correctly connected to the TRIGGER INPUT connector?
- Are the cables correctly connected to each pad or pedal?

When using an amp or audio system

- Are the TD-9's OUTPUT jacks connected correctly to the input jacks of your amp/audio system?
- Are the input selections and volume settings correct on that amp/audio system?
- Possible problem with the connection cables themselves?
- Isn't the [VOLUME] turned all the way to the left?
- Have the input select settings of your audio system or amp been made correctly?
- Is the amp or audio system volume setting correct?

When using headphones

- Are your headphones plugged into PHONES jack?

Turning the power off

1. Turn the volume down on the TD-9 and any connected equipment.

2. Power-off the connected equipment.

3. Hold down [POWER] until the screen indicates "POWER OFF."

After a moment, [POWER] goes dark.

Tensioning the pads

Tensioning the head of a mesh pad

BEFORE using the PD-105/85 mesh pads you must adjust the tension.

Use a drum key to make adjustments.

You can tension mesh heads the same way you do with acoustic drums.

MEMO

Adjusting the tension of the PD-105/85 head is only for playing response and will not affect the pitch as on an acoustic drum.

Adjusting the PD-105 head

1. Loosen all six tuning bolts until a gap appears between the tuning bolt and the hoop.
2. Finger-tighten all six tuning bolts.

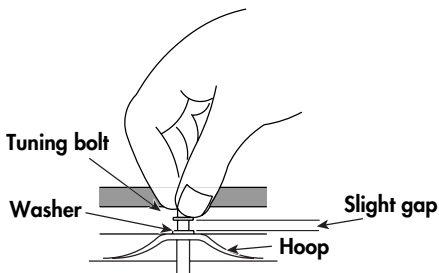

3. Using the drum key, tighten each of the six tuning bolts by two rotations.

Tighten the tuning bolts in the numerical order shown by the following illustration.

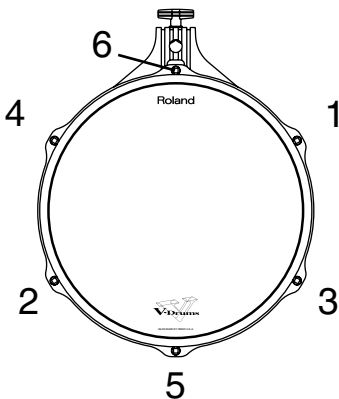

Tensioning the PD-85 head

1. Use the included drum key to tighten the tuning bolts.

Adjust the bolts so that the gap between the frame and hoop is consistent all the way around the hoop.

As the bolts have lock bushings (to prevent them from loosening), it will take some effort to turn them.

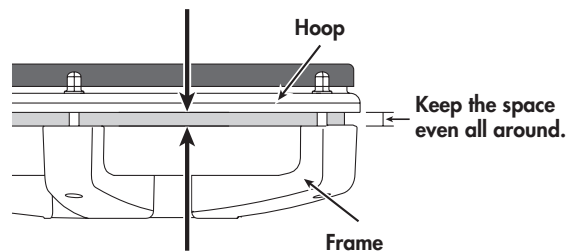

NOTE

Tighten the tuning bolts in the numerical order shown in the following illustration. If you firmly tighten a tuning bolt at one location all at once, it will be impossible to stretch the head evenly, and this may cause triggering response problems.

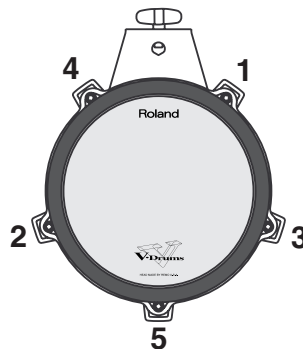

2. Tension the head evenly as you test the playing feel, just as you would with an acoustic drum.

MEMO

2. Performing



Selecting a drum kit

A drum kit is a combination of the sounds & settings for each pad and pedal, as well as ambience.

About the “DRUM KIT” screen

This is the TD-9’s basic screen; it appears when you press [KIT].

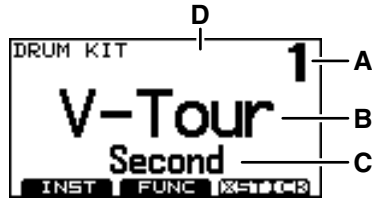

A	Drum kit number
B	Drum kit name
C	Sub-title (style, date, etc.)
D	Indicates “H” for Head Shot (p. 23) or “R” for Rim Shot. * If “Preview” (p. 15) is activated, either “H” or “R” will be displayed depending on the currently selected pad.

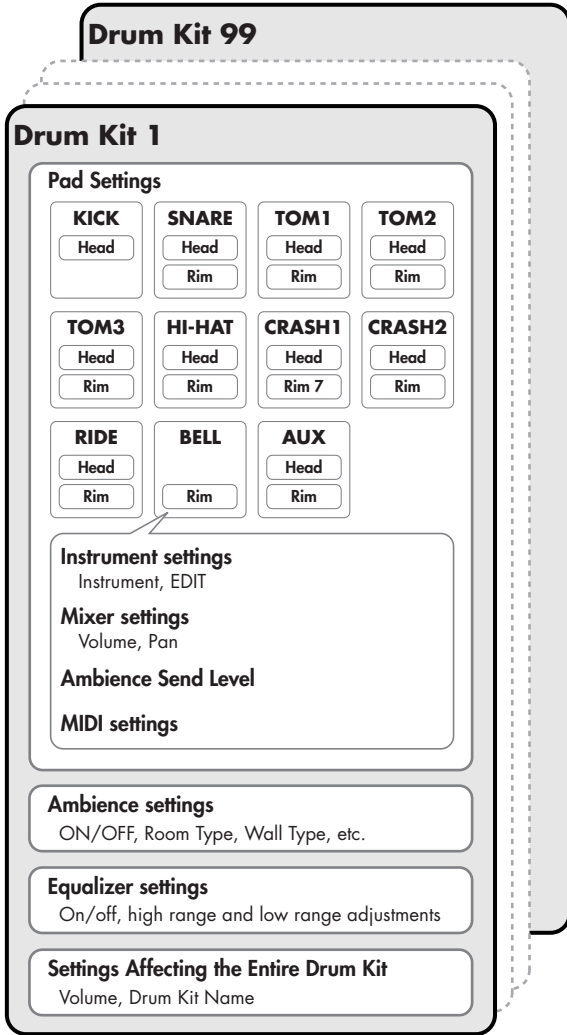

2. Use [+/-] or turn [VALUE] to select a drum kit.

MEMO

Regardless of the screen that is displayed, pressing [KIT] will access the “DRUM KIT” screen.

* [QUICK REC] is an exception to this.

Activating the cross stick function

By pressing [F3] [XSTICK], you can enable or disable the cross stick function.

- Cross stick sound can be heard



- Cross stick sound can not be heard



* It is effective only when you select the instrument with *X mark for SNARE.
refer to “Drum Instrument List” (p. 67).

Selecting a drum kit

1. Press [KIT].

[KIT] lights up, and the “DRUM KIT” screen appears.



Performance techniques

Pads (e.g., PD-105/PD-85)

Head Shot

Hit only the head of the pad.

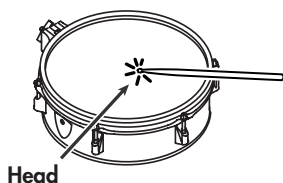

Rim Shot

Strike the head and the rim of the pad simultaneously.

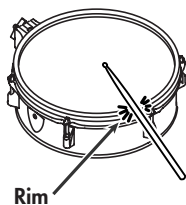

Cross Stick

When **XSTICK** (p. 22) is on

Only strike the rim of the pad.

Depending on the sound assigned to the rim you can play rim shots and/or cross stick sounds.

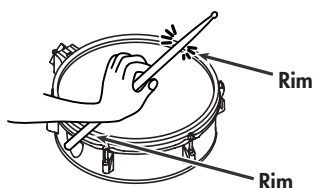

- * It is effective only when you select the instrument with *X mark for SNARE. refer to "Drum Instrument List" (p. 67).
- * Enable the cross stick function (press [KIT] - [F3] (XSTICK)); p. 22).
- * To play the cross stick, be sure that you only strike the rim of the pad. Place your hand on the head gently, otherwise this may prevent the cross stick function from working properly.

Cymbals (e.g., CY-8, CY-13R)

Bow Shot

The most common method, playing the middle area of the cymbal. It corresponds to the sound assigned to the "head" the relative trigger input.

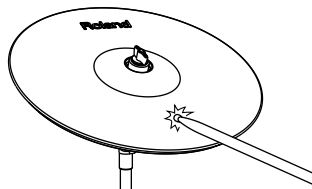

Edge Shot

When striking the edge with the shoulder of the stick (as shown in the figure), the sound assigned to the "rim" of the connected input will be heard.

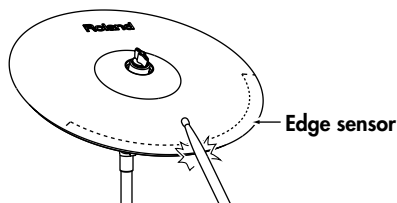

Bell Shot (CY-12R/C, CY-13R, CY-15R)

This playing method involves striking the bell of the cymbal, and when played as shown in the figure, the "rim" sound of the connected input will be heard.

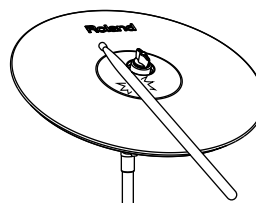

- * Strike the bell somewhat strongly with the shoulder of the stick.

Choking a cymbal

Choking (pinching) the cymbal's edge with the hand immediately after hitting the cymbal will mute or choke the sound, just like with a real cymbal. The Choke function only works when you grasp in the area (where the edge sensor is) as shown in the figure. If you do otherwise, it will not work.

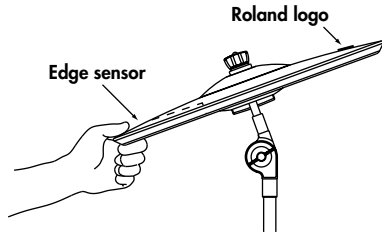

Hi-Hat (CY-5, VH-11)

Open/Closed

The hi-hat sound will change smoothly between open and closed depending on pressure applied to the hi-hat control pedal or a hi-hat stand (when using the optional VH-11). Foot closed and foot splash sounds are possible.

Bow Shot

When playing the middle area of the hi-hat pad, the sound assigned to the "head" will be heard.

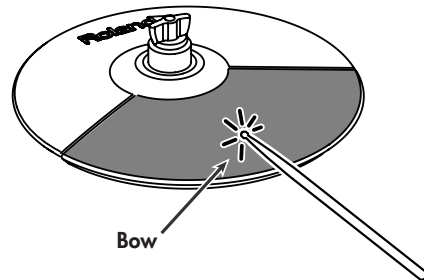

Edge Shot

When playing the edge of the hi-hat pad with the shoulder of the stick (as shown in the figure), the sound assigned to the "rim" will be heard.

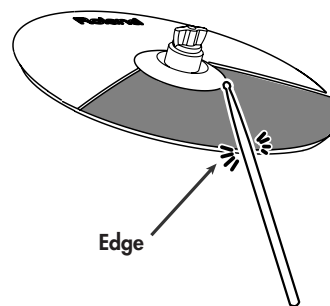

* Do not strike the side of the hi-hat pad.

Creating a drum kit

All sounds assigned to a drum kit can be edited for your specific purposes.

Selecting an instrument

On the TD-9, all sounds are referred to as “instruments” (INST).

1. Press [KIT]-[F1] (INST).

The “INST” screen appears.



“Group”: Type of instrument (instrument group)

“Inst”: Instrument name

2. Hit the desired pad or use CURSOR [◀] [▶] to select a pad.

The edit screen for the selected pad appears.

3. Use CURSOR [▲] [▼] to move the cursor to “Group” or “Inst.”

4. Use [+/-] or [VALUE] to select the instrument group or individual instrument.

5. Press [EXIT] to return to the “DRUM KIT” screen.

Editing instrument parameters

1. Press [KIT]-[F1] (INST).

The “INST” screen appears.

2. Press [F1] (EDIT).

The “INST EDIT” screen appears.

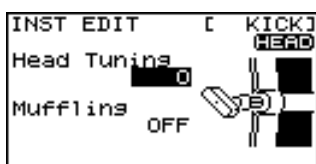

3. Hit the desired pad or use CURSOR [◀] [▶] to select a pad.

The edit screen for the selected pad appears.



4. Use CURSOR [▲] [▼] to select a parameter.

5. Use [+/-] or [VALUE] to edit the parameter you selected.

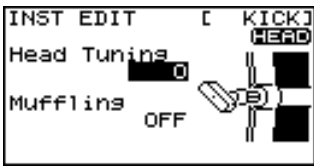
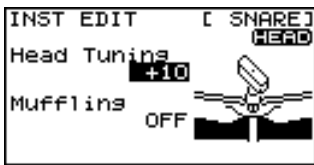
6. Press [EXIT] to return to the “DRUM KIT” screen.

Screen	Parameter	Value
	KICK	
	Head Tuning	-240– +240
	Muffling	OFF, TAPE1–2, BLANKET. WEIGHT
	SNARE	
	Head Tuning	-240– +240
	Muffling	OFF, TAPE1–2, DOUGHNUTS1–2

Creating a drum kit

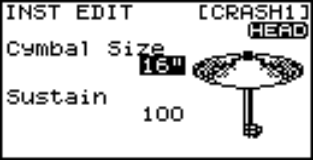
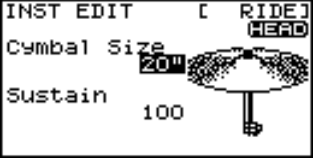
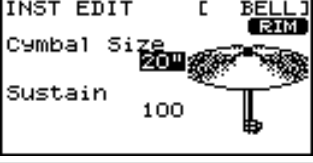
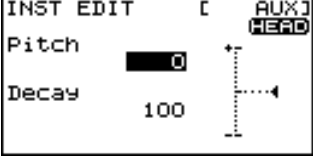
Screen	Parameter	Value
 <p>INST EDIT [TOM1] HEAD Head Tuning 0 Muffling OFF</p>	TOM1-3	
	Head Tuning	-240- +240
	Muffling	OFF, TAPE1-2, FELT1-2
 <p>INST EDIT [HI-HAT] HEAD Cymbal Size 14" Fixed Hi-Hat NORMAL</p>	HI-HAT	
	Cymbal Size	1"-40"
	Fixed Hi-Hat	NORMAL, FIXED1-4
 <p>INST EDIT [CRASH1] HEAD Cymbal Size 16" Sustain 100</p>	CRASH1-2	
	Cymbal Size	1"-40"
	Sustain	1-100
 <p>INST EDIT [RIDE] HEAD Cymbal Size 20" Sustain 100</p>	RIDE	
	Cymbal Size	1"-40"
	Sustain	1-100
 <p>INST EDIT [BELL] RIM Cymbal Size 20" Sustain 100</p>	BELL	
	Cymbal Size	1"-40"
	Sustain	1-100
 <p>INST EDIT [AUX] HEAD Pitch 0 Decay 100</p>	Other sounds	
	Pitch	-240- +240
	Decay	1-100

Using the Mixer (MIXER)

Adjusting the volume and pan (stereo position) of individual pads/pedals.

1. Press [KIT]-[F1] (INST).
The "INST" screen appears.
2. Press [F2] (MIXER).

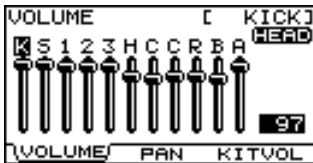

3. Press [F1]-[F3] to select the item you want to edit.

If you pressed [F1] or [F2]

- 4-1. Hit the desired pad or use CURSOR [<] [>] to select a pad.
- 4-2. Use CURSOR [▲] [▼] to select HEAD or RIM.

If you pressed [F3]

4. Use CURSOR [▲] [▼] to select a parameter.
5. Use [+/-] or [VALUE] to edit the value.
6. Press [EXIT] several times to return to the "DRUM KIT" screen or just press [KIT].

Screen	Parameter	Value	Description
	[F1] (VOLUME)		
	VOLUME	0-100	Volume of each pad
	[F2] (PAN)		
	PAN	L15-CTR-R15	Pan position of each pad
	[F3] (KITVOL)		
	Kit Volume	0-100	Volume of the entire drum kit
	Pedal HH Volume	0-100	Volume of the hi-hat's foot closed sound
	XStick Volume	0-100	Volume of cross stick sound
	XStick Threshold	0-127	Determines the velocity/dynamic at which the cross-stick and open rim shot sound will switch.
<p>Setting this to a high value makes it easier to get cross stick sounds. When set to "0," playing cross stick will produce the open rim shot sound.</p> <p>* A very high value may cause the cross stick to sound as when playing a rim shot.</p>			<p style="text-align: center;">Cross Stick Threshold (0-127)</p>

Using the onboard effects (AMB/EQ)

“Ambience” allows you to choose the environment where the drums are being played. You can adjust room size, wall material and the position of the ambience mics. The “Equalizer” is used to adjust the overall tone.

1. Press [KIT]-[F1] (INST).
The “INST” screen appears.
2. Press [F3] (AMB/EQ).
3. Press [F1] or [F3] to select the parameter you want to edit.
[F1] (AMB): Ambience
[F3] (EQ): Equalizer
4. Use CURSOR [▲] [▼] to select a parameter.
5. Use [+/-] or [VALUE] to edit the value of the parameter.
6. Press [EXIT] several times to return to the “DRUM KIT” screen or just press [KIT].



Screen	Parameter	Value
	[F1] (AMB)	
	Type	OFF, LIVING, BATH, STUDIO, GARAGE, LOCKER, THEATER, CAVE, GYM, DOME
	Size	TINY, SMALL, MEDIUM, LARGE, HUGE
	Wall	WOOD, PLASTER, GLASS
	Mic	LOW, HIGH
	Shape	0-100
	Level	0-100
	[F3] (EQ)	
	Switch	ON, OFF
	High Freq	1-8 kHz
	High Gain	-12- +12
	Low Freq	20 Hz-1 kHz
	Low Gain	-12- +12

Adjusting the ambience for each pad (SEND)

Each pad has an individual ambience send level.

3. Press [F2] (SEND).
The AMBIENCE SEND screen appears.
4. Hit the desired pad or use CURSOR [◀] [▶] to select a pad.
5. Use CURSOR [▲] [▼] to switch between HEAD and RIM.
6. Use [+/-] or [VALUE] to adjust the ambience the send level.
Value: 0-100
7. Press [EXIT] several times to return to the “DRUM KIT” screen or just press [KIT].

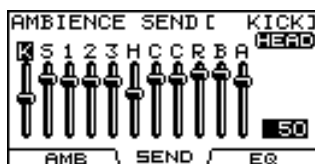

Naming a drum kit

You can create a name of up to twelve characters for each kit. A sub-title of up to sixteen characters can also be added below the name. This is useful for song indications, dates, styles etc.

1. Press [KIT]-[F2] (FUNC).

The "FUNCTION" screen appears.

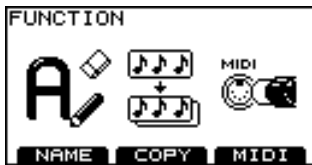

2. Press [F1] (NAME).

The "DRUM KIT NAME" screen appears.



3. Use CURSOR [▲] [▼] to move the cursor to the drum kit name or sub-title.
4. Use CURSOR [◀] [▶] to move the cursor to the character that you want to edit.
5. Use [+/-] or [VALUE] to change the character.

Function buttons

Function	Explanation
[F1] (INSERT)	Inserts a space at the cursor location, and moves subsequent characters one place to the right.
[F2] (DELETE)	Deletes the character at the cursor location, and moves subsequent characters one place to the left.
[F3] (CHAR)	Switches the type of character at the cursor location between uppercase, lowercase, and/or numbers and symbols.

6. Press [EXIT] several times to return to the "DRUM KIT" screen or just press [KIT].

Copying a drum kit or instrument

You can copy a complete drum kit or an individual instrument.

Settings that are copied

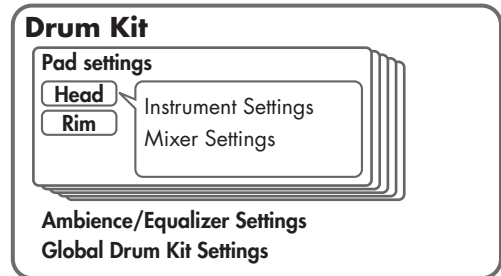

Drum kit

All settings of the drum kit will be copied.

Copied settings

Drum kit parameters

Overall settings for the drum kit:

Volume, drum kit name

Ambience:

On/off, performance location, wall material, depth, etc.

Equalizer:

On/off, high-frequency and low-frequency settings

Pad parameters

Instrument settings:

Instrument, EDIT

Mixer:

Volume, pan

Ambience send levels

MIDI settings

Instrument

Copying an instrument only copies the pad parameters: sounds assigned to the pad and rim.

Copied settings

- Instrument settings
- * Effect and mixer settings are not copied.

NOTE

The contents of the copy-destination are lost when executing the Copy operation. Please be careful.

Copying a drum kit

1. Press [KIT]-[F2] (FUNC).

The "FUNCTION" screen appears.



2. Press [F2] (COPY).

The "COPY" screen appears.



3. Press [F1] (KIT).

4. Use [CURSOR], [+/-], and [VALUE] to choose the copy-source and copy-destination.

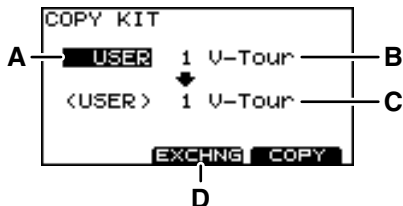

5. Press [F2] or [F3].

[F2] (EXCHNG):

All contents of the copy-source and copy-destination will be exchanged. (This is shown only if the copy-source is "USER.")

[F3] (COPY):

Contents of the copy-source will be overwritten onto the copy-destination.

A confirmation screen will appear.



* You can cancel by pressing [F1] (CANCEL).

6. Press [F3] (EXEC) to execute the copy or exchange.

Wait until the display indicates "Completed."

7. Press [EXIT] several times to return to the "DRUM KIT" screen or just press [KIT].

Types of copy-source	
A	PRESET: Preset (the ORIGINAL Roland factory settings)
	USER: User data
	Backup USB: Data saved on a USB Key. (optional)
* If you choose Backup USB, choose the backup number from which you want to copy data.	
B	Copy-source
C	Copy-destination
D	Exchange button
* This is shown only if the copy-source is "USER."	

TIP

- Exchange (EXCHNG) is a convenient way to rearrange your data.
- If you want to restore the factory settings of an individual kit, choose "PRESET" as the copy-source.

Copying an instrument

1. Press [KIT]-[F2] (FUNC).

The "FUNCTION" screen appears.



2. Press [F2] (COPY).

The "COPY" screen appears.



3. Press [F2] (INST).

4. Use [CURSOR], [+/-], and [VALUE] to choose the copy-source and copy-destination.

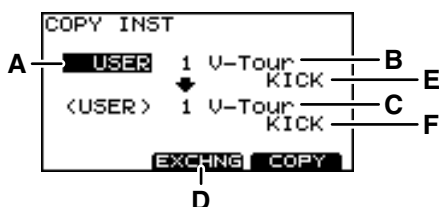

	Types of copy-source
	PRESET: Preset (the ORIGINAL Roland factory settings)
A	USER: User data
	Backup USB: Data saved on a USB Key. (optional)
	* If you choose Backup USB, choose the backup number from which you want to copy data.
B	Copy-source
C	Copy-destination
D	Exchange button
	* This is shown only if the copy-source is "USER."
E	Copy-source pad
F	Copy-destination pad

TIP

- Both the HEAD and RIM instruments will be copied.
- If you want to restore the factory settings, choose "PRESET" as the copy-source.
- If the cursor is located at E or F, you can choose the copy-source or copy-destination pad by striking a pad directly.

5. Press [F2] or [F3].

[F2] (EXCHNG):

Contents of the copy-source and copy-destination will be exchanged. (This is shown only if the copy-source is "USER.")

[F3] (COPY):

The contents of the copy-source will be overwritten onto the copy-destination.

A confirmation screen will appear.

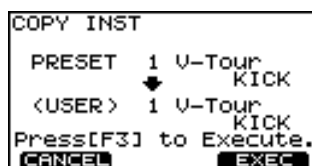

- * If you decide to cancel, press [F1] (CANCEL).

6. Press [F3] (EXEC) to execute the copy or exchange.

When the copy or exchange is completed, the display will indicate "Completed."

7. Press [EXIT] several times to return to the "DRUM KIT" screen or just press [KIT].

NOTE

- If you choose KICK as the copy source, only the HEAD will be copied to the copy destination.
- In the case of RIDE, the HEAD, RIM, and BELL (all three) of the RIDE cymbal will be copied simultaneously only if you choose RIDE as both the copy source and copy destination.

MIDI parameters for each pad & pedal

1. Press [KIT]-[F2] (FUNC).

The "FUNCTION" screen appears.



2. Press [F3] (MIDI).

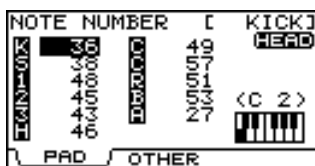

3. Press [F1] or [F2] to select the parameter you want to edit.

If you pressed [F1]

4-1. Use [CURSOR] to select the pad/parameter.

4-2. While holding down [SHIFT], use CURSOR [▲] [▼] to switch between HEAD and RIM, or play the desired rim/pad or pedal

If you pressed [F2]

4. Use CURSOR [▲] [▼] to select the parameter.

5. Use [+/-] or [VALUE] to edit the value.

6. Press [EXIT] several times to return to the "DRUM KIT" screen or just press [KIT].

Screen	Parameter	Value	Description
	[F1] (NOTE)		
	NOTE NUMBER	0-127, OFF	MIDI Note Numbers transmitted by each pad/pedal
* If you select a note number already assigned another pad, an "*" appears on the left-side of the note number.			
	[F2] (HI-HAT)		
	HH Open (Bow)	0-127, OFF	MIDI Note Numbers transmitted by bow shot of open hi-hat
	HH Closed (Bow)	0-127, OFF	MIDI Note Numbers transmitted by bow shot of closed hi-hat
	HH Open (Edge)	0-127, OFF	MIDI Note Numbers transmitted by bow edge of open hi-hat
	HH Closed (Edge)	0-127, OFF	MIDI Note Numbers transmitted by edge shot of open hi-hat
	HH Pedal	0-127, OFF	MIDI Note Numbers transmitted by pedal hi-hat
	Xstick	0-127, OFF	MIDI Note Numbers transmitted by cross stick
* The HH Compatibility and HH Note# Border setting is required to transmit switches between the open and closed hi-hat. For details, refer to p. 54.			
* If you select a note number already assigned another pad, an "*" appears on the left-side of the note number.			

MEMO

If you're using an external MIDI device (Midi controller pad, keyboard or sequencer) to play the TD-9's internal sounds, note numbers transmitted to the TD-9 will trigger the instrument of the pad that is assigned to that note number.

3. Playing along with music



Playing with the internal songs or from a USB memory key

The TD-9 contains fifty songs of various styles. Enjoy playing the TD-9 along with them.

You can also play the TD-9 while listening to songs (audio files) saved to an optional USB memory key.

Song Function profile

The internal songs consist of “drum,” “percussion,” and “bass and others” parts. Each part can be muted individually. The tempo for these songs can also be adjusted.

- * It is not possible to mute just the bass part.

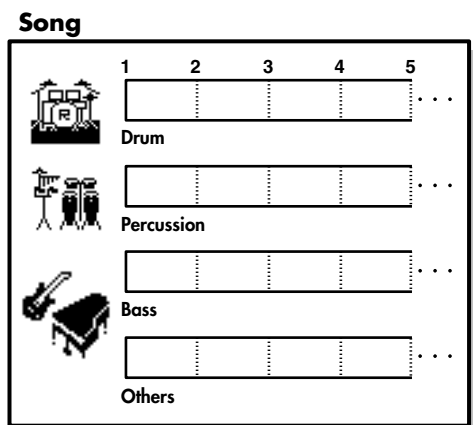

About Song Copyright

The internal songs contained in this product are sound recordings protected by copyright. Roland hereby grants to purchasers of this product the permission to utilize the sound recordings contained in this product for the creation and recording of original musical works; provided however, the sound recordings contained in this product may not be sampled, downloaded or otherwise re-recorded, in whole or in part, for any other purpose, including but not limited to the transmission of all or any part of the sound recordings via the internet or other digital or analog means of transmission, and/or the manufacture, for sale or otherwise, of any collection of sampled songs, on CD-ROM or equivalent means. The sound recordings contained in this product are the original works of Roland Corporation. Roland is not responsible for the use of the sound recordings contained in this product, and assumes no liability for any infringement of any copyright of any third party arising out of use of the songs in this product.

- All rights reserved. Unauthorized use of this material for purposes other than private, personal enjoyment is a violation of applicable laws.
- No data for the music that is played will be output from MIDI OUT.

Audio files that can be played by the TD-9

On the following formats of Audio files, saved to your USB key, can be used.

Audio files		
WAV	Sampling rate	44.1 kHz
	Bit depth	8/16/24 bit, Linear PCM
MP3	Sampling rate	44.1 kHz
	Bit rates	32/40/48/56/64/80/96/112/128/160/192/224/256/320kbps, VBR (Variable Bit Rate)

- Save the audio files in the root directory of your USB memory key.
- The song name will be the name of the file.
- Use single-byte alphanumeric (ASCII) characters for the file name.
- The TD-9 can recognize files that have a name consisting of no more than 95 characters (not including the file name extension).
Recommended length of file name: 12 characters or less (not including the file name extension)
- The TD-9 can recognize up to 200 audio files. Keep the number of audio files on your USB memory key to 200 or fewer.
- Make sure that no single file is larger than 2 GB.

Connecting USB memory key

When connecting a USB memory key, insert it all the way into the connector without using excessive force.

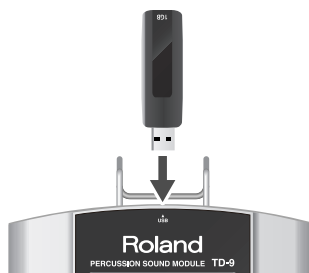

NOTE

- **Use USB memory key sold by Roland!**
We cannot guarantee operation if other products are used.
- Do not unplug USB memory key from the TD-9 while the USB memory access indicator is blinking. Doing so may damage the USB memory key or the data.
- Do not connect any device other than USB memory key to the USB memory connector.

Song selection

1. Press [SONG].

The button will light, and the "SONG" screen appears.



2. Use [+/-] or [VALUE] to select a song.

No.	Title	Composer
5	New Disco	Michael Schack
19	Break Beat	
20	Jump'n Bass	
35	Break BeatPtn	

What's in "SONG" screen

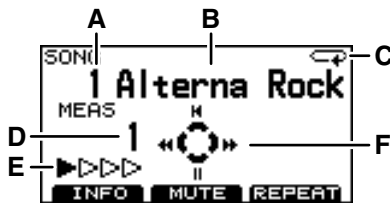

A	Song number Indicates the number of the currently selected song.
B	Song name Indicates the name of the currently selected song.
C	Song playback type (p. 37)
	Measure number
D	When you press [▶/■], playback begins from the measure shown here.
E	Beat
F	[CURSOR] functions (refer to "Playing a song")

Playing a song



- Use [+/-] or [VALUE] to select the song you want to play.
- Press [▶/■].
[▶/■] lights up and the song will begin playing.
- To stop playback, press [▶/■].
[▶/■] goes dark, and you will return to the beginning of the song.

[CURSOR] functions

Button	Display	Function
[▲]	⏮	Returns to the beginning of the song.
[▼]	⏸	Pauses the song playback. Press again to resume playback from where you paused.
[◀]	⏭	Advances to the next measure.
[▶]	⏪	Returns to the previous measure.

Selecting a song from USB memory key

Songs (audio files) saved on a USB memory key are shown following the internal songs.

- Use [+/-] or [VALUE] to switch songs until the top line of the screen shows "EXTERNAL SONG."

* You can also hold down [SHIFT] and press [SONG] to select external songs.



- Press [▶/■].

[▶/■] lights up and the song will begin playing.

Playing with the internal songs or from a USB memory key

3. To stop playback, press [▶/■].

[▶/■] goes dark, and you will return to the beginning of the song.

[CURSOR] functions

Button	Display	Function
[▲]	⏮	Returns to the beginning to song.
[▼]	⏸	Pauses the song playback. Press again to resume playback from where you paused.
[◀]	⏭	Fast-forwards the song.
[▶]	⏪	Rewinds the song.

Setting the tempo

* This will not work for songs (audio files) in USB memory key.

1. Hold down [SHIFT] and [TEMPO].

The "TEMPO" screen appears.

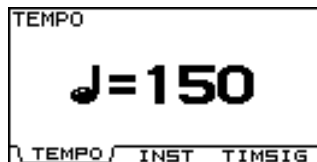

2. Use [+/-] or [VALUE] to adjust the tempo.

3. Press [SONG] to return to the "SONG" screen or just press [KIT].

TIP

The "INFORMATION" screen (p. 37) you can view the standard tempo of the song. If you've modified the song's tempo and want go back to the original tempo, adjust it in "INFORMATION" screen.

Muting a part

You can mute (silence) the playback of a specific part in a song.

* This will not work with songs (audio files) on a USB memory key.

1. Press [SONG]-[F2] (MUTE).

The "PART MUTE" screen appears.

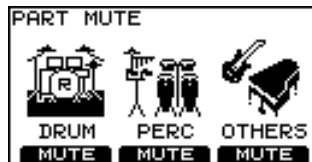

2. Press [F1]-[F3] to mute on/off for each part.

Muting will turn on/off each time you press the button.

[F1]	DRUM (Drum part) * If you mute the drum part, [MUTE] will light.
[F2]	PERC (Percussion part)
[F3]	OTHERS Bass + other parts * Each press of the button will cycle through the following indications. • OTHERS muted (BASS is not muted) • BASS/OTHERS are muted • Mute off

Example: Muting the drum part

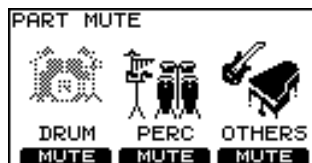

3. Press [SONG] to return to the "SONG" screen.

Muting the drum part

Each time you press [MUTE], the drum part will be muted (button is lit) or un-muted (button is dark).

* This will not work for songs (audio files) in USB memory key.

Viewing song information / Editing song settings

1. Press [SONG]-[F1] (INFO).

The "INFORMATION" screen appears.

INFORMATION	
Name	Alterna Rock
Length	57
Time Signature	4/4
Tempo(♩: 93)	♩=120
Type	ONESHOT
Song Volume	60

- Use CURSOR [▲] [▼] to select a parameter.
- Use [+/-] or [VALUE] to edit the value.
- Press [EXIT] to return to the "DRUM KIT" screen or just press [KIT].

Song information

Parameter	Description	
Name	Song name	
Length	Number of measures	* For an internal song
Time Signature	Time signature	
Total Time	Length of song (hours: minutes: seconds)	* For an audio file (on a USB key)

Settings

Parameter	Value	Description
Tempo	20-300	Song playback tempo
Type	LOOP, ONESHOT	Song playback type

LOOP:

Once playback reaches the end of the song, it returns to the beginning and repeats. Playback will continue until you press [STOP].

Very convenient for practicing drums with a song.

(↺) appears in the upper right of the "SONG" screen for songs that are set to LOOP.

ONESHOT:

One playback reaches the end of the song, it stops.

(→) appears in the upper right of the "SONG" screen for songs that are set to ONESHOT.

Song Volume	0-100	Song volume
-------------	-------	-------------

MEMO

The audio file's Song Volume and Type settings are saved to USB memory key when you switch off the TD-9's power while USB memory key is connected, or when you save User Data (p. 57) to USB memory key.

Using the Repeat function (Repeat)

This function allows you to select a specific section of a song, and have it repeat.

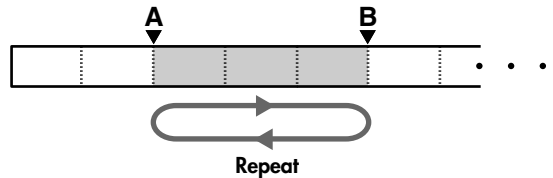

MEMO

The minimum length for which you can specify a repeat is one measure for the internal songs, and one second for an audio file.

- Select the song that you want to play, and press [▶/■].
[▶/■] will light, and the song will begin playing.
- to mark the beginning of the section you want to repeat, press [F3] (REPEAT).
The (A) indicator will appear in the screen.



- At the end of the section you want to repeat, press [F3] (REPEAT).

The (A)(B) indicators will appear in the screen, and playback will repeat between points A and B.



To cancel the Repeat function, press [F3] (REPEAT) once again.

Using the MIX IN

- * Lower the volume
- * If a connection cable noise occurs, use connection cables that are shielded.

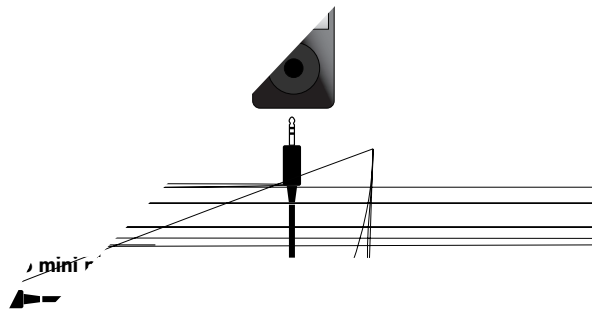

4. Practicing

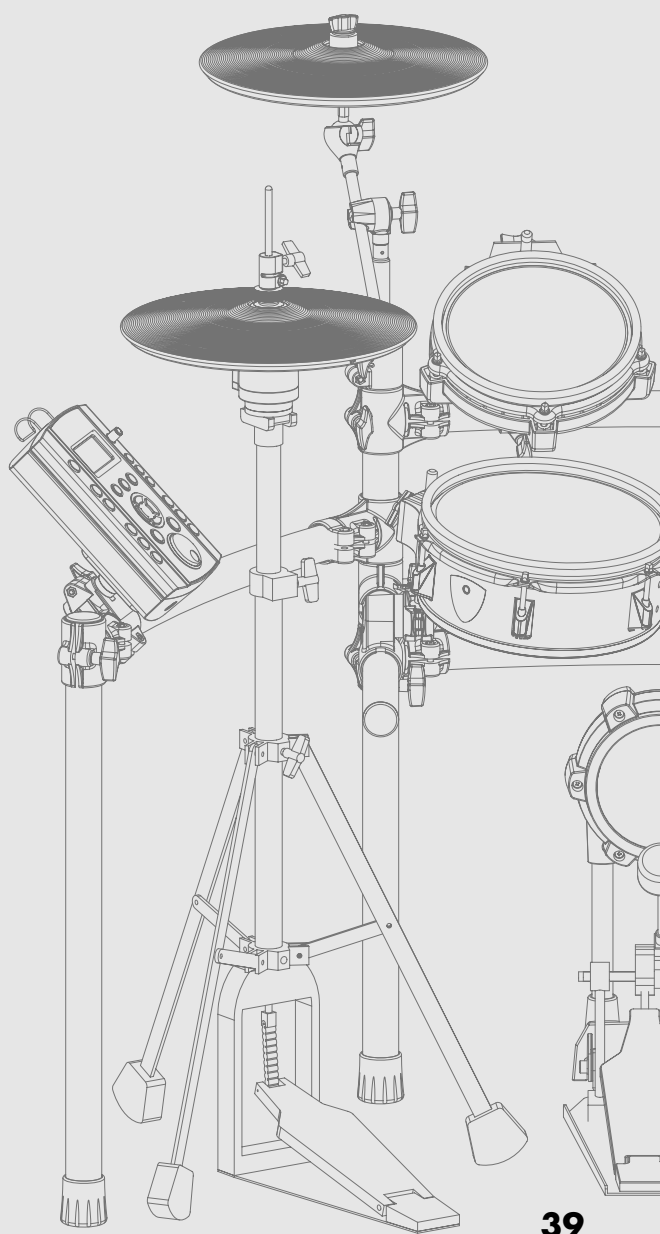

On Board Metronome

Practicing with the TD-9's built in metronome will help you perfect your tempo skills.

Using the metronome

1. Press the [CLICK (TEMPO)] button.
The [CLICK (TEMPO)] button lights up and the metronome starts.
2. Play along with it or press the button again to stop it.

Metronome parameters

You can change the tempo, sound, and time signature of the metronome.

1. Hold down [SHIFT] and press [CLICK (TEMPO)].
The "TEMPO" screen appears.
2. Choose the screen containing the parameter you want to change.
Tempo: Press [F1] (TEMPO).
Sound: Press [F2] (INST).
Time signature: Press [F3] (TIMSIG).
* If you pressed [F1] (TEMPO), proceed to step 4.
3. Use CURSOR [▲] [▼] to select a parameter.
4. Use the [+/-] buttons or the [VALUE] knob to edit the value.
5. Press [EXIT] to return to the "DRUM KIT" screen or just press [KIT].

Changing the tempo (TEMPO)



Value: 20–300

Changing the metronomes sound (CLICK INST)



Parameter	Value	Description
Inst	See below	Click sound
	METRONOME, CLICK, VOICE, BEEP1, BEEP2, TEK CLICK, STICKS, CLAVES, WOOD BLOCK, COWBELL, AGOGO, TRIANGLE, TAMBOURINE, MARACAS, CABASA	
Volume	0–100	Volume of the metronome sound
Pan	L15–CENTER–R15	Panning of the sound

Changing the time signature (TIME SIGNATURE)



Parameter	Value	Description
Time Signature	Numerator: 0–15 Denominator: 2, 4, 8, 16	Metronome's time signature
Interval	1/2 (half note), 3/8 (dotted quarter note), 1/4 (quarter note), 1/8 (eighth note), 1/12 (eighth note triplets), 1/16 (16th note)	Click interval
Count In Play	OFF, 1 MEAS (one measure), 2 MEAS (two measures)	Number of measures of count-in added before a song plays
Quick Rec Click	OFF, ON	Click on/off status during QUICK REC

* If you specify a numerator of "0," there will be no accent on the first beat.

* If this is ON, the click will always be on when [QUICK REC] is lit.

Quick recording and playback (QUICK REC / QUICK PLAY)

The TD-9 provides a Quick Rec function that lets you easily record your own performance, and a Quick Play function that immediately plays back what you recorded.

This is a very useful practice tool, recording and then checking your drumming.

MEMO

Maximum number of recordable notes: approximately 32,000 notes

- * The number of recordable notes will be less if your performance includes extensive use of the hi-hat control pedal.

QUICK REC

Recording and playing your performance

- * First: Please select the drum kit that you want to use for recording.
- * A signal input via the MIX IN jack won't be recorded.

1. Press [QUICK REC].

[QUICK REC] will light and the "QUICK REC" screen appears.



- If "Quick Rec Click" (p. 40) is ON, [CLICK (TEMPO)] will light up, and the metronome starts. You can turn it off by pressing [CLICK (TEMPO)] and the button will go dark.

2. Use [+/-] or the [VALUE] knob to set the tempo.

3. Hit any pad/pedal and recording begins.

The following screen appears.

- * Sounds that receive through MIDI IN can be also recorded.



4. To stop recording, press [QUICK REC] and the button goes dark.

- * If you exceed the maximum recording time, recording stops automatically.

Recording together with a song

- * First: Please select the drum kit that you want to use for recording.
- * Audio file on the USB memory key can not be recorded.
- * A signal input via the MIX IN jack won't be recorded.

1. Press [QUICK REC].

[QUICK REC] will light and the "QUICK REC" screen appears.



- At the same time, [MUTE] lights up and the song's drum part will be automatically muted.
- If "Quick Rec Click" (p. 40) is ON, [CLICK (TEMPO)] will light up, and the metronome starts. You can turn it off by pressing [CLICK (TEMPO)] and the button will go dark.
- If you press [QUICK REC] while the song is playing, recording begins immediately.

2. Use [+/-] or [VALUE] to set the tempo.

3. Press [▶/■].

Recording will begin at the same moment that the song starts.

- * If "Count In Play" (p. 40) is 1MEAS or 2MEAS, recording begins after the one or two measure count in.

The following screen will appear.



- * Previously recorded data will be erased when a new recording starts.

4. Now just play & record along with the song.

5. When you want to stop recording, press [▶/■].

- * If you exceed the maximum recording time, recording stops automatically.

MEMO

You can save your recorded performances to a USB memory key. For details, please refer to "Saving data recorded by Quick Rec" (p. 58).

Playback

1. Press [QUICK PLAY] and the button lights up.

The "QUICK PLAY" screen appears, and playback begins.



The following buttons correspond to various playback functions.

Button	Function
[▲]	Returns to the beginning of what you have recorded.
[▼]	Pauses the playback of that recorded performance. Press this button again to resume playback from the paused location.
[◀]	Advances to the next measure.
[▶]	Returns to the previous measure.

2. To stop playback, press [QUICK PLAY] and the button goes dark.

When playback has finished, [QUICK PLAY] automatically goes dark.

- * [QUICK PLAY] only plays back performances recorded using Quick Rec.

Using the Scope function (SCOPE)

The Scope function provides an on-screen view of the timing of your drumming.

This will help you improve timing control in the tempo and time signature of your own choosing.

1. Press [SCOPE] and the button lights up.

The "SCOPE" screen appears.

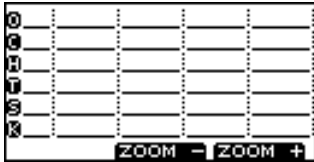

- The [CLICK (TEMPO)] will light up as the metronome begins playing.

MEMO

- The grid is relative to the metronome's time signature (p. 40).
- If you want to change the tempo or time signature please see "Metronome parameters" (p. 40).
- You can also play back a song while using the Scope function.
- Sounds that received through MIDI IN are also shown in the line of "Others."

2. Play the pads while listening to the metronome.

Your timing will be shown in the display.

* Foot-close is not shown.

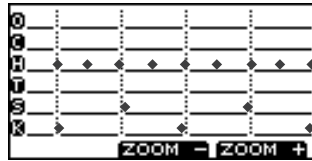

• [F3] (ZOOM +) button

Each time you press this button, the display of one beat will be magnified.

This lets you view one beat in greater detail.

* [F2] (ZOOM -) button

Each time you press this button, the viewing area will expand.

This lets you view more beats at once.

3. When you want to turn off the Scope function, press [SCOPE] or [EXIT].

Viewing the SCOPE screen

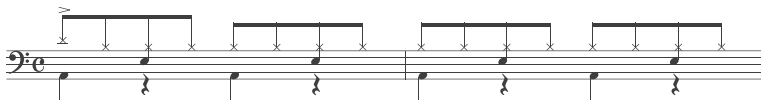

Timing of your strikes

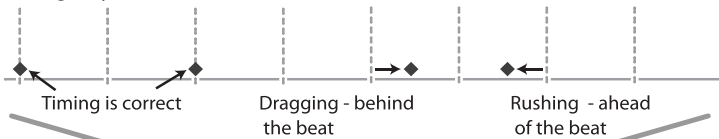

Others
Cymbals
Hi-hat
Toms
Snare
Kick

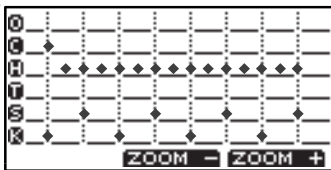

When your timing is good

Others
Cymbals
Hi-hat
Toms
Snare
Kick

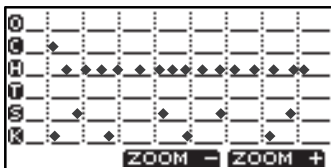

When your timing is inaccurate

MEMO

5. Advanced applications

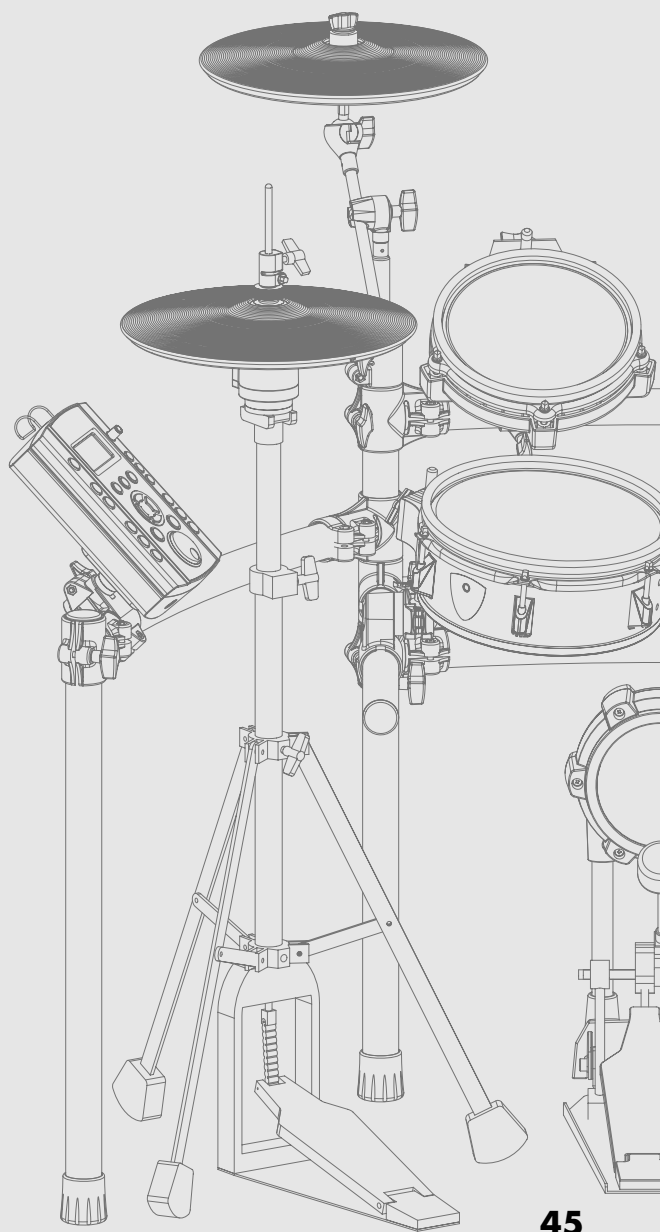

Setting the Pad Sensitivity [F2] (BASIC)

When you specify the trigger type (p. 46), the following settings (basic trigger parameters) are automatically set to the values appropriate for each pad, meaning that you will normally not need to adjust them. If you wish to make detailed adjustments, you can edit the following parameters.

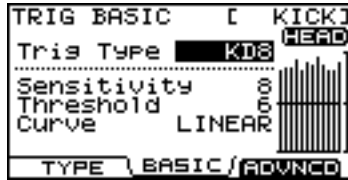

MEMO

The velocity monitor at the right of the screen indicates the velocity of the last twelve hits, starting with the most recent.

Parameter	Value	Description
Trig Type	refer to p. 46	
Sensitivity	1-32	You can adjust the sensitivity of the pads to accommodate your personal playing style. This allows you to have more dynamic control over the sound volume, based on how hard you play. Higher sensitivity allows the pad to produce a loud volume even when played softly. Lower sensitivity will keep the pad producing a low volume even when played forcefully.
Threshold	0-31	This setting allows a trigger signal to be received only when the pad is above a determined dynamic level (velocity). This can be used to prevent a pad from sounding because of vibrations from other pads. In the following example, B will sound but A and C will not sound. When set to a higher value, no sound is produced when the pad is struck lightly. Gradually raise the "Threshold" value while striking the pad. Check this and adjust accordingly. Repeat this process until you get the perfect setting for your playing style.
	See below	This setting allows you to control the relation between playing velocity (striking force) and changes in volume. Adjust this curve until the response feels as natural as possible.
Curve		<div style="display: flex; justify-content: space-between;"> <div style="width: 45%;"> <p>LINEAR The standard setting. This produces the most natural correspondence between playing dynamics and volume change.</p> </div> <div style="width: 45%;"> <p>SPLINE Extreme changes are made in response to playing dynamics.</p> </div> </div> <div style="display: flex; justify-content: space-between; margin-top: 10px;"> <div style="width: 45%;"> <p>EXP1, EXP2 Compared to LINEAR, strong dynamics produce a greater change.</p> </div> <div style="width: 45%;"> <p>LOUD1, LOUD2 Very little dynamic response, making it easy to maintain strong volume levels. If using drum triggers, these settings help maintain stable levels.</p> </div> </div> <div style="display: flex; justify-content: space-between; margin-top: 10px;"> <div style="width: 45%;"> <p>LOG1, LOG2 Compared to LINEAR, a soft playing produces a greater change.</p> </div> </div>

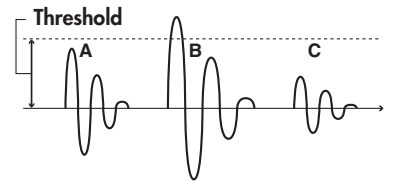

Detailed settings for trigger parameters [F3] (ADVNC D)

The following parameters (Advanced Trigger Parameters) are automatically set to the most efficient values for each pad when you select the Trigger Type (p. 46). They don't require adjustment, except if you experience any of the problems that are discussed in the explanation of each parameter.

1. Press [F1]–[F3] to choose the item that you want to edit.
2. Use CURSOR [▲] [▼] to choose a parameter.
3. Use [+/-] or [VALUE] to edit the value.
4. Press [EXIT] several times to return to the "DRUM KIT" screen or just press [KIT].

[F1] (SCAN)

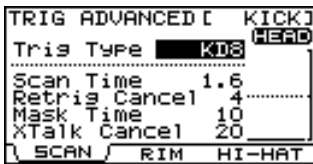

Parameter	Value	Description
Trig Type	refer to p. 46	
Scan Time	0–4.0 (ms)	<p>Specifies the detection time for the trigger signal. Since the rise time of the trigger signal waveform may differ slightly depending on the characteristics of each pad or acoustic drum trigger (drum pickup), you may notice that identical hits (velocity) may produce sound at different volumes. If this occurs, you can adjust the "Scan Time" so that your way of playing can be detected more precisely.</p> <p>While repeatedly hitting the pad at a constant force, gradually raise the Scan Time value from 0 msec, until the resulting volume stabilizes at the loudest level. At this setting, try both soft and loud strikes, and make sure that the volume changes appropriately.</p> <p>* As the value is set higher, the time it takes for the sound to be played increases. Set this to the lowest value possible.</p>
Retrig Cancel	1–16	<p>This setting prevents spurious re-triggering. Important if you are using acoustic drum triggers. Such triggers can produce altered waveforms, which may also cause inadvertent sounding at Point A in the following figure (Re-trigger). This occurs in particular at the decaying edge of the waveform. Re-trigger Cancel detects such distortion in and prevents re-triggering from occurring.</p> <p>While repeatedly striking the pad, raise the "Retrig Cancel" value until re-triggering no longer occurs.</p> <p>* While repeatedly striking the pad, raise the "Retrig Cancel" value until re-triggering no longer occurs.</p> <p>MEMO</p> <p>You can also eliminate this problem of re-triggering with the Mask Time setting. Mask Time does not detect trigger signals if they occur within the specified amount of time after the previous trigger signal was received. Re-trigger Cancel detects the attenuation of the trigger signal level, and triggers the sound after internally determining which trigger signals were actually generated when the head was struck, while weeding out the other false trigger signals that need not trigger a sound.</p>

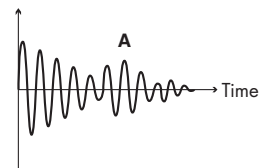
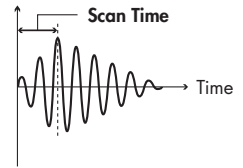

Parameter	Value	Description
Mask Time	0–64 (ms)	<p>This setting prevents double triggering. When playing a kick trigger, the beater can bounce back and hit the head a second time immediately after the intended note—with acoustic drums sometimes the beater stays against the head—this causes a single hit to “double trigger” (two sounds instead of one). The Mask Time setting helps to prevent this. Once a pad has been hit, any additional trigger signals occurring within the specified “Mask Time” (0–64 msec) will be ignored.</p> <p>Adjust the “Mask Time” value while playing the pad. When using a kick trigger, try to let the beater bounce back and hit the head very quickly, then raise the “Mask Time” value until there are no more sounds made by the beater rebound.</p> <p>* When set to a high value, it will be difficult to play very quickly. Set this to as low a value as you can.</p> <p>MEMO If two or more sounds are being produced when you strike the head just once, then adjust Retrig Cancel.</p>
XTalk Cancel	0–80	<p>This setting cancels “crosstalk”, which means that when you play one pad you hear a sound coming from another pad. This can happen when two pads are installed on the same stand. In some cases you can prevent crosstalk by increasing the distance between the two mounted pads.</p> <p>TIP In some cases you can prevent crosstalk by increasing the distance between the two mounted pads.</p> <p>Crosstalk Example: If you hit the snare pad and the tom 1 also sounds Set the snare and tom 1 to the same XTALK GROUP. Raise the “XTALK CANCEL” for the pad being used for tom 1. The tom 1 pad will be less prone to receive crosstalk from other pads.</p> <p>* If the value is set too high, and two pads are played simultaneously, the one that is struck less forcefully may not sound. Be careful and set this parameter to the minimum value required to prevent crosstalk.</p>

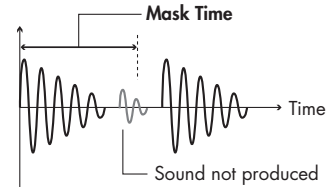

[F2] (RIM)

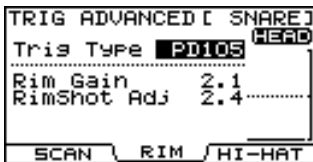

Parameter	Value	Description
Trig Type	refer to p. 46	
Rim Gain	0–8.0	When a PD-125/120/105/85/80R, PDX-8, PD-9/8/7, CY series pad, VH-11, or RT-10S is connected, you can adjust the relation between your playing velocity (force) on the rim/edge and the resulting volume level. Higher value allows the rim/edge to produce a loud volume even when played softly. Lower value will keep the rim/edge producing a low volume even when played forcefully.
RimShot Adj	0–8.0	When a PD-125/120/105/85/80R, PDX-8, or RT-10S is connected, you can adjust the sensitivity of the rim response. There are some cases that you have a rim sound unexpectedly when you hit the head strongly. You can improve this situation with decreasing the value of “RimShot Adjust.” When you set the value too small, it might be difficult to play the rim sound.

[F3] (HI-HAT)

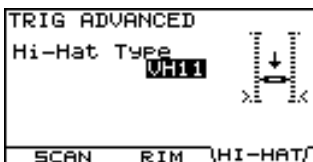

Parameter	Value	Description
Hi-Hat Type	VH11, FD8	Select the type of hi-hat controller you’re using.

Connecting the VH-11 and making settings on the TD-9

Connections

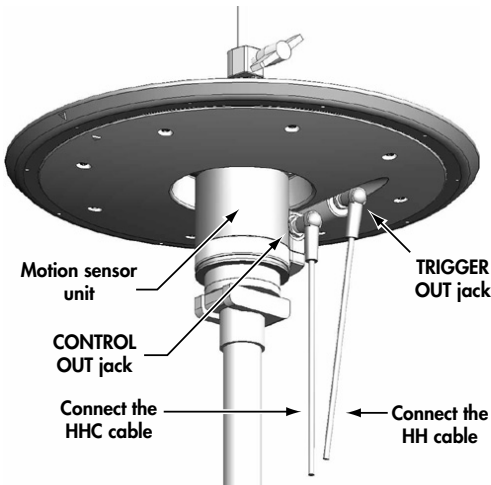

Settings

1. Make sure that the VH-11 is correctly connected to the TD-9.
2. Set up the hi-hat, take your foot off the pedal, and power-on the TD-9.
 - * It will be impossible to make the adjustment correctly if the hi-hat is touching the motion sensor when you turn on the power.
3. Loosen the clutch screw, and allow the hi-hat to rest naturally on top of the motion sensor unit.
4. Press [SETUP]-[F1] (TRIG).
The "TRIGGER TYPE" screen will appear.
5. Use [CURSOR] to move the cursor to "H" (HI-HAT).
6. Use [+/-] or [VALUE] to choose "VH11."



7. Press [F3] (ADVNC)-[F3] (HI-HAT).

The following screen will appear.



8. Verify the TD-9's setting.

Parameter	Value
Hi-Hat Type	VH11

9. While you watch the meter that's displayed in the right side of the screen, turn the VH-11's VH offset adjustment screw to adjust it.

Adjust the screw so that the black  appears in the meter.

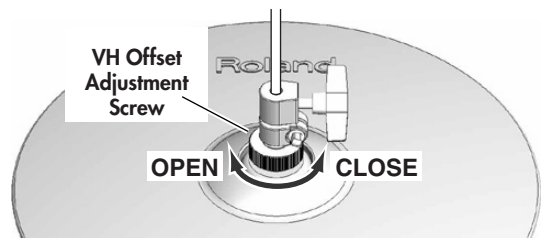
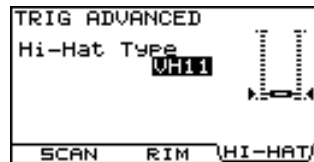

VH Offset Adjustment Points

If the closed hi-hat sound is difficult to attain, rotate the VH offset adjustment screw towards "CLOSE."

If the open hi-hat sound is difficult to attain, rotate the screw towards "OPEN."

NOTE

If the sound cuts off when you strike the hi-hat forcefully, rotate the VH Offset adjustment screw towards "OPEN."

10. Adjust other parameters as needed.

NOTE

If you don't set up the VH-11 correctly, it may not operate correctly.

If the Clutch Was Apart from the Hi-Hat

If the hi-hat clutch is inadvertently removed from the hi-hat, use the following procedure to reassemble and attach the clutch.

NOTE

Due to the different shape, the clutch included with the hi-hat stand cannot be used with the VH-11. Be sure to use the special VH-11 clutch.

Hi-Hat Being Properly Assembled

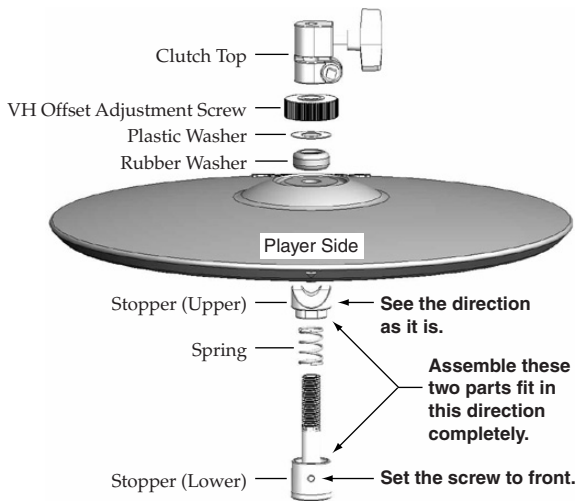

* Orient the stopper (upper) so that it matches the groove in the hi-hat.

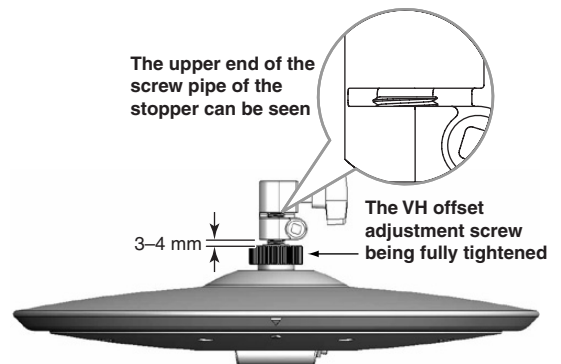
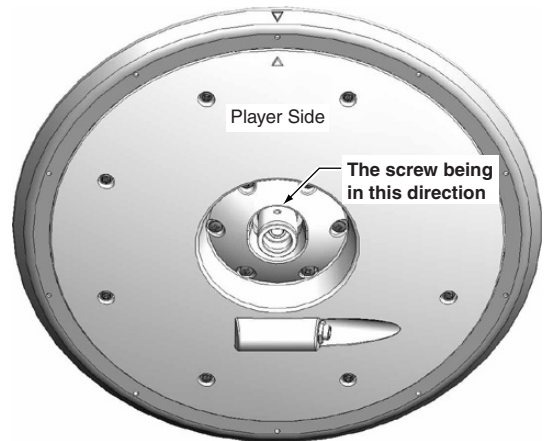

MIDI-related settings

There are many possibilities when using MIDI, such as:

Use the pads to play external instruments

You can layer sounds on the TD-9 as well as play sounds from MIDI sound modules and samplers.

Use the TD-9 as a sound module

If you're using an external MIDI sequencer to perform with an ensemble, you can use the TD-9 as a dedicated drum sound module.

When used with a MIDI sound module, rather than just being capable of using percussion sets, the TD-9 can handle an even greater number of instruments simultaneously.

1. Press [SETUP].

[SETUP] will light, and the "SETUP" screen will appear.



2. Press [F2] (MIDI).

The "MIDI" screen will appear.



3. Use CURSOR [▲] [▼] to select a parameter.

4. Use [+/-] or [VALUE] to edit the value.

5. Press [EXIT] several times to return to the "DRUM KIT" screen or just press [KIT].

MIDI settings for the entire TD-9 [F1] (GLOBAL)

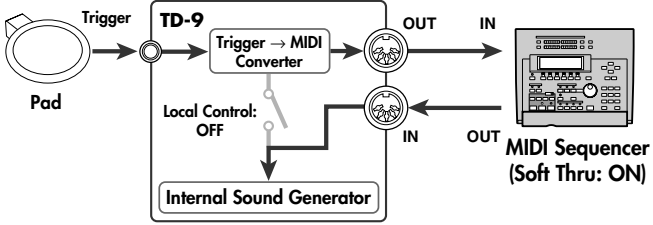
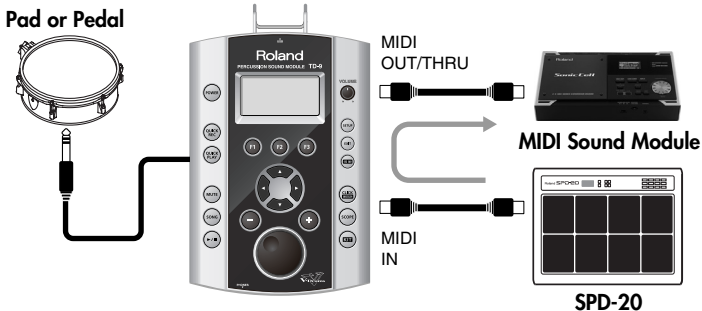

Parameter	value	Description
Tx/Rx Channel	CH 1-CH16, OFF	Specifies the transmit/receive channel. * If you set the drum part to "CH11," it will be the same as the TD-9's percussion part, and the percussion part will no longer sound.
Tx PC	OFF, ON	Specifies whether program change messages will be transmitted to an external MIDI device (ON) or not transmitted (OFF). With the "ON" setting, a program number corresponding to the selected drum kit will be transmitted when you switch drum kits on the TD-9.
Rx PC	OFF, ON	Specifies whether program change messages sent from an external MIDI device will be received (ON) or not received (OFF). With the "ON" setting, the TD-9 will switch to the drum kit corresponding to the received program number.
Note Chase	OFF, ON	Turns the Note Chase on/off. This is convenient during the editing process. Received MIDI data will automatically call up the settings screen for the relative instrument/pad, and automatically moves the cursor.

Parameter	value	Description
<p>Local Control</p>	<p>OFF, ON</p>	<p>Turns the Local Control on/off.</p> <p>This is required when you want to trigger sounds in an external sound module and/or record your performance on an external MIDI sequencer, and NOT use the TD-9's internal sounds. If that is your need, then turn Local Control to "OFF." When recording/using TD-9 performances on an external sequencer, turn Local Control to "OFF" and be sure the sequence's MIDI OUT is connected to the TD-9's MIDI In.</p> <p>The trigger signals from the pads go directly to the MIDI OUT/THRU connector.</p> <p>The TD-9's default mode is with Local Control "ON."</p> <p>If you make connections and record as shown, with a setting of Local Control "ON," duplicate notes will be re-transmitted to the TD-9 and will not be played correctly.</p> 
<p>Soft Thru</p>	<p>OFF, ON</p>	<p>Turns the Soft Thru function on/off.</p> <p>This explains how you can use the Roland SPD-20 (a MIDI controller) together with the TD-9's pads to play internal sounds and an external sound module.</p> <p>When Soft Thru is set to "ON," the messages received at MIDI IN will also be transmitted from the MIDI OUT/THRU connector.</p> 

MIDI settings for precise expressiveness in performances [F2] (CTRL)

```

MIDI CONTROL
Pedal CC      FOOT<4>
HH Compatibility
              TD9/TD20
    
```

```

MIDI CONTROL
Pedal CC      FOOT<4>
HH Compatibility
              EXTERNAL
HH Note# Border 90
    
```

Parameter	value	Description
PedalCC	OFF, MODULATION(1), FOOT(4), GENERAL1(16)	Specifies the MIDI control change message used to transmit/receive the depth to which the hi-hat pedal is pressed.
HH Compatibility	TD-9/TD-20, EXTERNAL	<p>This is a setting for the MIDI messages transmitted when you're using an external MIDI sound module to sound the notes played by the TD-9 and pads.</p> <p>TD9/TD20: Choose this setting if you're using just the TD-9 and pads, or if you're using a TD series unit such as the TD-9 or TD-20 as your MIDI sound module. MIDI messages appropriate for the TD series will be transmitted.</p> <p>EXTERNAL: Choose this setting if you're using an external MIDI sound module other than the TD series. If you choose this setting, the display will indicate "HH Note# Border."</p>
HH Note# Border	0-127	<p>This setting lets you transmit MIDI messages that are appropriate for the MIDI sound module you're using.</p> <p>The note number transmitted when you strike the hi-hat will change depending on the amount of pressure on the hi-hat pedal.</p> <p>HH Border allows you to adjust the pedal position at which the note number switches from the open hi-hat to the closed hi-hat.</p> <p>As you monitor the note number transmitted by the TD-9 and the Control Change message value, adjust the setting until the note number is switched at the pedal position you want.</p> <p>When using a VH-11 for the hi-hat, setting this value to around 80 allows you to transmit the closed hi-hat note number when the pedal is slightly above the fully depressed position.</p> <p>NOTE If you change the HH Border setting, the hi-hat of a pattern that was recorded onto the internal sequencer by playing the pads may play back in a way that is different from the actually recorded performance.</p>

Editing a percussion set [F3] (PERC)

A collection of different percussion instruments is called a **percussion set**. A different percussion instrument is assigned to each note number, and multiple instruments can be used together.

NOTE

The percussion part is to CH11 (fixed).

Editing the Percussion Set

Select an instrument for each note number.

1. Press [SETUP]-[F2] (MIDI).
The "MIDI" screen will appear.
2. Press [F2] (PERC).
The "PERCUSSION SET EDIT" screen appears.
3. Use CURSOR [▲] [▼] to select a note number.
4. Use [+/-] or [VALUE] to select an instrument.

TIP

You can get a preview by holding down [SHIFT] and pressing [KIT].



Individual Percussion Instrument Parameters

Set the volume, pan, pitch, decay, etc. for each percussion instrument.

1. In the "PERCUSSION SET EDIT" screen, select the instrument whose settings you want to edit.
2. Press [F1] (EDIT).
The "PERCUSSION INST EDIT" screen appears.
3. Use CURSOR [▲] [▼] to select the parameter.
* You can use CURSOR [◀] [▶] to switch note numbers.
4. Use [+/-] or [VALUE] to edit the value.

TIP

You can get a preview by holding down [SHIFT] and pressing [KIT].

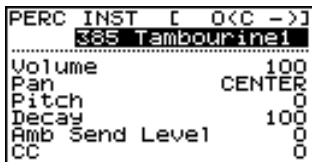

5. Press [EXIT] several times to return to the "DRUM KIT" screen or just press [KIT].

Parameter	value	Description
Instrument	001–533	Selects the instrument that will be assigned to the currently selected note number.
Volume	0–100	Specifies the volume of each instrument.
Pan	L15–CENTER–R15	Specifies the panning of each instrument.
Pitch	-240– +240	Specifies the pitch of each instrument.
Decay	1–100	Specifies the duration (decay time) of each instrument.
Amb Send Level	0–100	Specifies the ambience depth of each instrument.
CC	0–127	Adjusts the openness of the hi-hat. * This is valid only if the Instrument is "HH."

Other settings (Utility)

1. Press [SETUP]-[F3] (UTIL).

The "UTILITY" menu screen appears.



2. Press [F1]-[F3] to choose the item you want to edit.

Overall settings for the TD-9 [F1] (UTILITY)

"UTILITY" screen



Using a pad as a switch (Pad Switch)

A pad connected to the TRIGGER IN AUX jack can function as a switch to change drum kits or to start/stop a song.

* This setting is valid only in the DRUM KIT screen and the SONG screen.

NOTE

You must select the correct trigger type (p. 46) for the pad that's connected.

1. Use **CURSOR [▲] [▼]** to move the cursor to "AUX Head" or "AUX Rim."
2. Use **[+/-]** or **[VALUE]** to select the function that you want to control.

Function	Description
OFF	Disables the pad switch function.
KIT INC	Selects the next kit.
KIT DEC	Selects the previous kit.
SONG START	Starts song playback.
SONG STOP	Stops song playback.

Adjusting the display contrast (LCD Contrast)

The visibility of the display can be affected by the viewing angle or the brightness of the room. If you have difficulty reading the display, adjust the contrast as follows.

1. Use **CURSOR [▲] [▼]** to move the cursor "LCD Contrast."
2. Use **[+/-]** or **[VALUE]** to adjust the contrast.
Value: 1-16

TIP

You can also adjust the contrast by holding down [KIT] and turning [VALUE].

Setting the preview velocity (Preview Velocity)

By holding down [SHIFT] and pressing [KIT] you can play an instrument to preview (audition) its settings. Here's how to set the velocity (volume) of the preview function.

1. Use **CURSOR [▲] [▼]** to move the cursor to "Preview Velocity."
2. Use **[+/-]** or **[VALUE]** to adjust the preview velocity.
Value: 1-127

Using USB memory [F2] (USB)

“USB UTILITY” screen

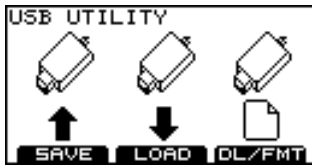

Saving data to a USB memory key (SAVE)

Here's how to save TD-9 data to a USB memory key.

Data that will be saved

- Backup data: TD-9 settings (drum kit and setup settings)
- Performance data recorded using Quick Rec function

Saving backup data

1. In the “USB UTILITY” screen, press [F1] (SAVE).

The “UTILITY USB SAVE” screen appears.



2. Press [F1] (BACKUP).

The “SAVE BACKUP DATA” screen appears.

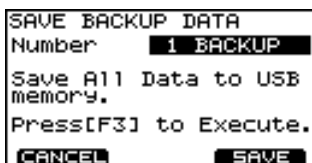

3. Use [+/-] or [VALUE] to specify the save-destination number.

Vacant numbers are indicated as (EMPTY).

4. Press [F3] (SAVE).

A confirmation screen appears.

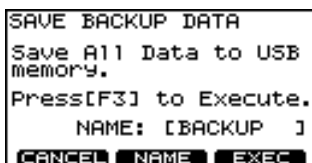

- * If you select a number where data has already been saved and then press [F3] (SAVE), a message will ask you to confirm it's OK to overwrite the existing data. If you want to overwrite the existing data, press [F3] (OK). If you decide to cancel, press [F1] (CANCEL) and select a different save-destination number.

Next you may assign a name to the data that will be saved. If you don't need to assign a name, proceed to step 9.

5. Press [F2] (NAME).

The “BACKUP DATA NAME” screen will appear.

You can assign a name (backup name) of up to eight characters.



6. Use CURSOR [▶] [◀] to move the cursor to the character that you want to change.
7. Use [+/-] or [VALUE] to select the desired character.

Function buttons

Function	Description
[F1] (INSERT)	Inserts a space at the cursor location and moves the subsequent characters one place to the right.
[F2] (DELETE)	Deletes the character at the cursor location, and moves the subsequent characters one place to the left.
[F3] (CHAR)	Switches the type of character at the cursor location between uppercase, lowercase, and numerals and symbols.

8. When you've completed the name, press [EXIT] to return to the previous screen.
9. Press [F3] (EXEC).
If you decide to cancel, press [F1] (CANCEL).
When data has been saved, the display says “Completed” and you'll return to the “DRUM KIT” screen.

Saving data recorded by Quick Rec

1. In the "USB UTILITY" screen, press [F1] (SAVE).

The "UTILITY USB SAVE" screen appears.



2. Press [F2] (Q REC).

The "SAVE QUICK REC DATA" screen appears.



3. Use [+/-] or [VALUE] to select the save-destination number.

Vacant numbers are indicated as (EMPTY).

4. Press [F3] (SAVE).

A confirmation screen appears.



* If you select a number where data has already been saved and then press [F3] (SAVE), a message will ask you to confirm it's OK to overwrite the existing data. If you want to overwrite the existing data, press [F3] (OK). If you decide to cancel, press [F1] (CANCEL) and select a different save-destination number.

Next you may write a name about the data that will be saved. If you don't need a comment, proceed to step 9.

5. Press [F2] (NAME).

The "QUICK REC DATA NAME" screen will appear. You can write a name of up to eight characters.



6. Use CURSOR [▶][◀] to move the cursor to the character that you want to change.
7. Use [+/-] or [VALUE] to select the desired character.

Function buttons

Function	Description
[F1] (INSERT)	Inserts a space at the cursor location and moves the subsequent characters one place to the right.
[F2] (DELETE)	Deletes the character at the cursor location, and moves the subsequent characters one place to the left.
[F3] (CHAR)	Switches the type of character at the cursor location between uppercase, lowercase, and numerals and symbols.

8. When you've completed the name, press [EXIT] to return to the previous screen.
9. Press [F3] (EXEC).
If you decide to cancel, press [F1] (CANCEL).
When data has been saved, the display says "Completed" and you'll return to the "DRUM KIT" screen.

Loading data from a USB memory key back into the TD-9 (LOAD)

Data you've saved on a USB memory key can be loaded back into the TD-9. This is called "Load."

Loading backup data

1. In the "USB UTILITY" screen, press [F2] (LOAD).

The "UTILITY USB LOAD" screen appears.



2. Press [F1] (BACKUP).

The "LOAD BACKUP DATA" screen appears.



3. Use CURSOR [▲] [▼] to move the cursor to "Load Data."

4. Use [+/-] or [VALUE] to select the specific data that will be loaded into the TD-9.

ALL: All settings

KIT: Drum kits

SETUP: Setup settings

5. Use CURSOR [▲] [▼] to move the cursor to "Number."

6. Use [+/-] or [VALUE] to select the specific data that will be loaded into the TD-9.

7. Press [F3] (LOAD).

A confirmation screen appears.



8. To load the data, press [F3] (EXEC).

If you decide to cancel, press [F1] (CANCEL).

When data has been loaded, the display says

"Completed" and you'll return to the "DRUM KIT" screen.

Loading Quick Rec data

1. In the "USB UTILITY" screen, press [F2] (LOAD).

The "UTILITY USB LOAD" screen appears.



2. Press [F2] (Q REC).

The "LOAD QUICK REC DATA" screen appears.

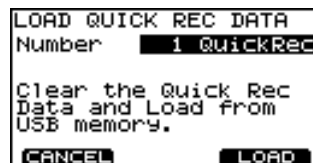

3. Use CURSOR [▲] [▼] to move the cursor "Number."

4. Use [+/-] or [VALUE] to select the specific data that will be loaded into the TD-9.

5. Press [F3] (LOAD).

A confirmation screen appears.

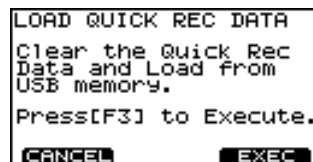

6. To load the data, press [F3] (EXEC).

If you decide to cancel, press [F1] (CANCEL).

When data has been loaded, the display says

"Completed" and you'll return to the "DRUM KIT" screen.

Deleting data from a USB memory key / Formatting a USB memory key (DL/FMT)

How to delete saved data from USB memory key and formatting the USB memory key.

Deleting backup data

1. In the "USB UTILITY" screen, press [F3] (DL/FMT).

The "USB DELETE/FORMAT" screen appears.



2. Press [F1] (BACKUP).

The "DELETE BACKUP DATA" screen appears.



3. Use [+/-] or [VALUE] to select the specific data that you want to delete.

4. Press [F3] (DELETE).

A confirmation screen appears.



5. To delete the data, press [F3] (EXEC).

If you decide to cancel, press [F1] (CANCEL).

When data has been deleted, the display says

"Completed" and you'll return to the "DRUM KIT" screen.

Deleting Quick Rec data

1. In the "USB UTILITY" screen, press [F3] (DL/FMT).

The "USB DELETE/FORMAT" screen appears.



2. Press [F2] (Q REC).

The "DELETE QUICK REC DATA" screen appears.

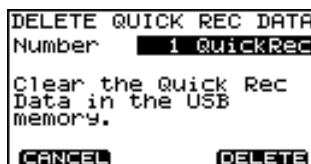

3. Use [+/-] or [VALUE] to select the specific data that you want to delete.

4. Press [F3] (DELETE).

A confirmation screen appears.



5. To delete the data, press [F3] (EXEC).

If you decide to cancel, press [F1] (CANCEL).

When data has been deleted, the display says

"Completed" and you'll return to the "DRUM KIT" screen.

Formatting a USB memory key

NOTE

When executing the Format operation, all data on the USB memory key (backup data, Quick Rec data, and audio files) will be lost.

1. In the "USB UTILITY" screen, press [F3] (DL/FMT).

The "USB DELETE/FORMAT" screen appears.



2. Press [F3] (FORMAT).

The "USB FORMAT" screen appears.

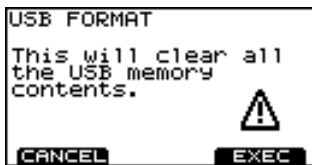

3. Press [F3] (EXEC).

If you decide to cancel, press [F1] (CANCEL).
A confirmation screen appears.



4. To execute the Format operation, press [F3] (OK).

If you decide to cancel, press [F1] (CANCEL).
When formatting is done, the screen will indicate "Completed" and you will return to the "DRUM KIT" screen.

Restoring the factory settings [F3] (RESET)

The "Factory Reset" operation returns all settings of all pads and instruments stored in the TD-9 to their factory-set condition.

NOTE

- All data and settings in the TD-9 will be lost. If you want to keep any of your data or settings, save them to USB memory before you continue.
- If you want to retain the Song Volume and Type settings (p. 37) of the audio files in USB memory key, disconnect the USB memory key before you execute the Factory Reset. If you execute the Factory Reset while USB memory key is connected, the audio file settings will be lost.

1. In the "UTILITY" menu screen, press [F3] (RESET).

The "FACTORY RESET" screen appears.



2. Press [F3] (EXEC).

If you decide to cancel, press [F1] (CANCEL).
A confirmation screen appears.

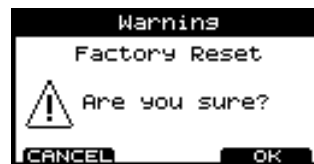

3. To execute the factory reset, press [F3] (OK).

If you decide to cancel, press [F1] (CANCEL).
When the factory reset is finished, the screen will indicate "Completed" and you will return to the "DRUM KIT" screen.

Changing the default trigger type

You can change the default trigger type values that will be assigned when a Factory Reset is executed.

Normally, you will not need to change this, but if the drum system you're using has different pads and trigger types, you can change the settings as follows.

1. Turn off the power.
2. Press [POWER] to turn on the power. Then, while "Roland" is showing in the screen, press both [SHIFT] and [SETUP] simultaneously.

The "DEFAULT TRIG SETTING" screen appears.



3. Use [+/-] or [VALUE] to select the drum system you're using.
4. Press [F3] (WRITE).

If you decide to cancel, press [F1] (CANCEL).
A confirmation screen appears.

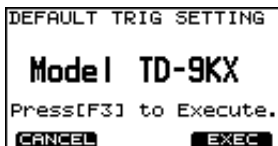

5. To carry out the change in default trigger type, press [F3] (EXEC).

If you decide to cancel, press [F1] (CANCEL).

Once the change has been completed, you're returned to the "DRUM KIT" screen.

TD-9KX2 default values



TD-9K2 default values

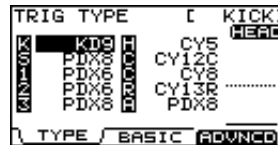

TD-9KX default values



TD-9K default values

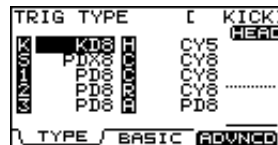

6. Appendices

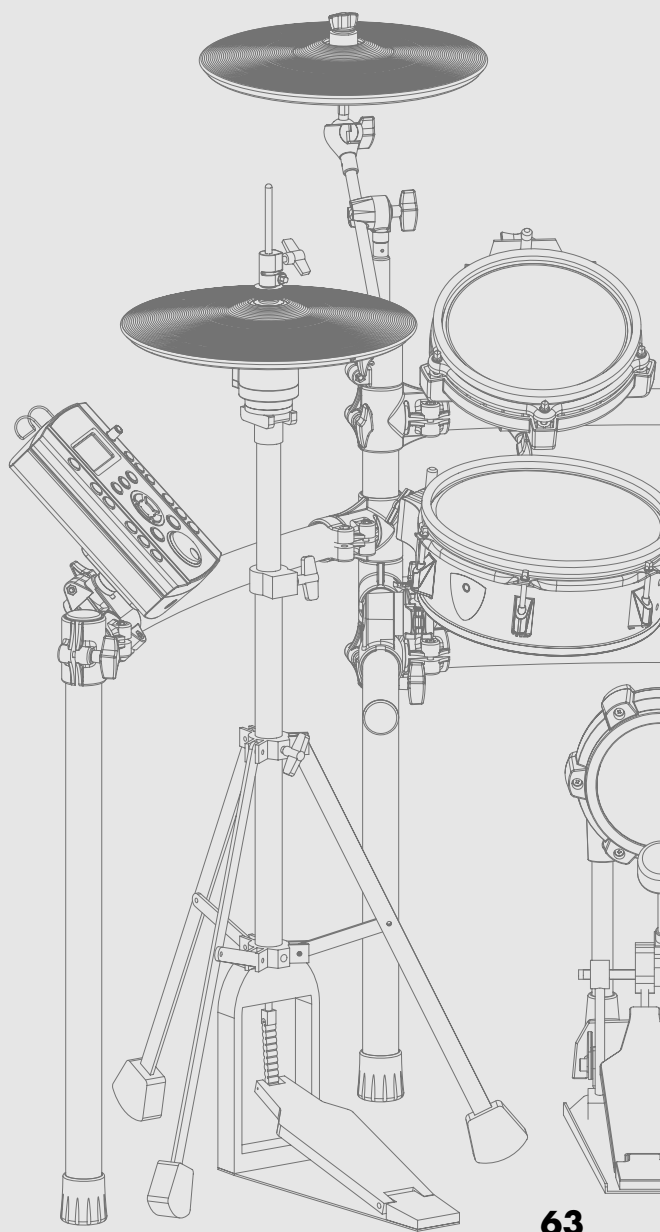

Error Messages

If an error message appears in the TD-9's screen, the TD-9 has failed to operate correctly for some reason, or an incorrect operation has been performed. Please take the appropriate action described here.

Message	Meaning	Action
MIDI-related error messages		
MIDI Offline!	A MIDI cable was disconnected. (Or communication with the external MIDI device stopped for some reason.)	Make sure that MIDI cables have not been pulled out or broken.
MIDI Com Error!!	A problem has occurred with the internal system.	Contact your dealer or a nearby Roland service center.
Receive buffer full!	A large amount of MIDI messages were received in a short time, and could not be processed completely.	Confirm that the external MIDI device is properly connected. If the problem persists, reduce the amount of MIDI messages sent to the TD-9.
Transmit buffer full!	The TD-9 was attempting to transmit more data than could be correctly output from MIDI OUT.	Reduce the amount of data that is being transmitted.
USB-related error messages		
USB memory not Ready!	USB memory key is not connected.	Connect your USB memory key to the USB memory connector.
No file!	The specified data does not exist in USB memory key.	
USB Memory Full	The USB memory key does not have sufficient free space.	Delete unneeded data.
Broken Data!!	The saved data is damaged.	
Decrease the number of wav files.	The speed of access to USB memory key has slowed down because the number of files has increased.	Decrease the number of files.
Check USB memory!	The USB memory key is not operating correctly.	Check the USB memory key.
Remove the USB device!	Either a USB device not usable by the TD-9 is connected, or foreign matter has entered the USB memory connector, causing a short.	Immediately disconnect the device, and check that no foreign matter has entered the USB memory connector.
QUICK REC-related error messages		
Memory Full!	No more memory capacity for Quick Rec.	Save your recording data on the USB memory key, and then start further recording.
System-related error messages		
Unknown System Error	A problem has occurred with the internal system.	Contact your dealer or a nearby Roland service center.

Preset Drum Kit List

No.	Name	No.	Name	No.	Name	No.	Name	No.	Name
1	V-Tour Second	21	Alterna BluesRock	41	V-Tour Studio	61	JazzFunk	81	Samba Batucada
2	Funky JAZZ	22	R&B Ballad	42	CoolJazz	62	90'sRock	82	Symphony OrchHits
3	Heavy ROCK	23	Blues ROCK	43	Double BASS	63	80'sRock	83	SteelDrm CMajorScale
4	NeoFunk	24	LowRock +SFX	44	Compact 18"Kick	64	70'sRock	84	Trancy
5	Thrash METAL	25	JazzHop	45	Acoustic	65	Dry Pop	85	Electron Electronica
6	Jungle 2ndHi-Hat	26	Ambient Drum'n Bass	46	House +LatinPerc	66	Lo-Fi	86	EleDrums ClassicElec
7	Breaker	27	Tech HOUSE	47	Ambient ChillOut	67	FunkyDry	87	TR-808
8	Shorty	28	Jazz Contemporary	48	Junk INDUSTRIAL	68	NewDisco	88	TR-909
9	Stomp!!	29	70'sHard	49	TightHit 2ndHi-Hat	69	TripHop	89	Voices HumanBeatBox
10	Unplug +Percussion	30	Soulful 60's-70's	50	Brushes	70	HipHop OldSchool	90	User Kit
11	Swing JAZZ	31	Metal Progressive	51	Ballad Reverb	71	Drum'nBs	91	User Kit
12	Post Punk	32	NewWave +Synth	52	Big Rock Stadium	72	Break BEAT	92	User Kit
13	Lite Pop +Tambourine	33	Solid FUNK	53	Modern JAZZ	73	Nu Jazz BrokenBeat	93	User Kit
14	AcidJazz	34	Prog ROCK	54	JazzyBop Sizzle	74	Abstract	94	User Kit
15	Rock BALLAD	35	Dark METAL	55	Fusion	75	Gimmick BreakBeat	95	User Kit
16	Shuffle BLUES	36	DigiDrum	56	Alterna Rock/Punk	76	Minimal HOUSE	96	User Kit
17	ClubBeat Hybrid	37	Ska	57	Blast	77	Reggae +Timbale	97	User Kit
18	Jump'n BASS	38	=GATE= 80's Dance	58	Mixture	78	Latin FootClave	98	User Kit
19	Bossa LOUNGE	39	Latin Percussion	59	Groove	79	World1 Cajon,Djembe	99	User Kit
20	Lite Bop 2ndSnare	40	Horizon	60	Vintage 30's-40's	80	World2 Tabla,Baya		

Preset Song List

No.	Name
1	Alterna Rock
2	Cool Jazz
3	Neo Funk
4	Medium Pops
5	New Disco
6	Heavy Rock
7	Rock Ballad
8	Mixture Rock
9	70's Hard
10	Prog Rock
11	ShuffleBlues
12	Acid Jazz
13	Contemp Jazz
14	Jazzy Funk
15	Fusion
16	Urban R&B
17	NorthernSoul
18	SouthernSoul
19	Break Beat
20	Jump'n Bass
21	Post Punk
22	Thrash Metal
23	Ska
24	Bossa Nova
25	JazzSolo Ptn

No.	Name
26	FunkSolo Ptn
27	ProgSolo Ptn
28	MedPops Ptn
29	70'sHard Ptn
30	ContempJzPtn
31	Mixture Ptn
32	HeavyRockPtn
33	AcidJazz Ptn
34	R&B Ptn
35	BreakBeatPtn
36	NorthSoulPtn
37	Ska Ptn
38	Alt Rock Ptn
39	SouthSoulPtn
40	BossaNovaPtn
41	Samba
42	Flamenco12/8
43	Djembe
44	AfroCuban6/8
45	Salsa
46	Mambo
47	Son 3-2
48	Son 2-3
49	Rumba 3-2
50	Rumba 2-3

Drum Instrument List

No.	Name	No.	Name	No.	Name	No.	Name	No.	Name
KICK		39	ShortNoise K	78	30'sBrass S	118	CrossStick3	157	TR808 SR*X
1	Maple K	40	Dance K	79	30'sBrass SR*X	119	CrossStick4	158	TR808 XStick
2	Custom K	41	House K	80	Medium S	120	CrossStick5	159	TR909 S
3	Birch K	42	Hip K	81	Medium SR*X	121	VintBright S	160	TR909 SR*X
4	Shallow K	43	NuHip K	82	MediumSt S	122	VintBrightSR	161	TR909 XStick
5	Medium K	44	Dirty K	83	MediumSt SR*X	123	LiteSteel S	162	Elec1 S
6	Studio K	45	Rap K	84	MediumBr S	124	LiteSteel SR	163	Elec2 S
7	Wood K	46	Giant K	85	MediumBr SR*X	125	LiteBrass S	TOM	
8	Soft K	47	Lo-Fi K	86	Vintage S	126	LiteBrass SR	164	10"Maple T1
9	Vintage K	48	Blow K	87	Vintage SR*X	127	12"Maple S	165	10"Maple T1R
10	Oak K	49	Dororo K	88	VintCustom S	128	12"Maple SR	166	12"Maple T2
11	RoseWood K	50	Rumble K	89	VintCustomSR*X	129	Loose S	167	12"Maple T2R
12	26"Deep K	51	Ambient K	90	Birch S	130	Loose SR	168	14"Maple T3
13	18"Hybrid K	52	Destroyer K	91	Birch SR*X	131	7.0"Deep S	169	14"Maple T3R
14	OnePly K	53	Ninja K	92	WhiteAsh S	132	7.0"Deep SR	170	16"Maple T4
15	Plugged K	54	80'sHard K	93	WhiteAsh SR*X	133	Sustain S	171	16"Maple T4R
16	Heavy K	55	Gate K	94	PiccoloSt S	134	Sustain SR	172	10"Birch T1
17	Dry K	56	Phase K	95	PiccoloSt SR*X	135	TightBuzz S	173	10"Birch T1R
18	Meat K	57	Reverse K	96	PiccoloBr S	136	TightBuzz SR	174	12"Birch T2
19	Buzz K	58	Industrial K	97	PiccoloBr SR*X	SNARE OTHER		175	12"Birch T2R
20	Bop K	59	Door K	98	13" S	137	Whack S	176	14"Birch T3
21	R8Low K	60	Chunk K	99	13" SR*X	138	Cruddy S	177	14"Birch T3R
22	R8Dry K	61	Voice K	100	Dry S	139	HardComp S	178	16"Birch T4
23	Blast K	62	TR808 K	101	Dry SR*X	140	ShortBuzz S	179	16"Birch T4R
24	SolidMaple K	63	TR808Boom K	102	Fat S	141	Dance S	180	12"Custom T1
25	24"Loose K	64	TR909 K	103	Fat SR*X	142	Hip S	181	12"CustomT1R
26	24"LooseK /M	65	TR909Wood K	104	FatBr S	143	BreakBeat S	182	14"Custom T2
27	Thin K	66	TR909Hard K	105	FatBr SR*X	144	House S	183	14"CustomT2R
28	Coated K	67	Elec K	106	Heavy S	145	Garage S	184	16"Custom T3
29	Coated K /M	68	ElecBend K	107	Heavy SR*X	146	HouseDpn S	185	16"CustomT3R
30	24"Solid K	69	Elephant K	108	Dirty S	147	Clap S	186	18"Custom T4
31	24"SolidK /M	70	Gabba K	109	Dirty SR*X	148	Punch S	187	18"CustomT4R
32	18"Buzz K	71	Space K	110	Brush S	149	Radio S	188	12"Coated T1
33	18"Maple K	SNARE		111	Brush SR*X	150	NoisyXStickS	189	12"CoatedT1R
34	18"MapleK /M	72	Custom S	112	Copper S	151	DenseClick S	190	14"Coated T2
35	18"FloorT K	73	Custom SR*X	113	Copper SR*X	152	Gate S	191	14"CoatedT2R
36	Muted K	74	VintMaple S	114	Reggae S	153	Reverse S	192	16"Coated T3
37	LiteBuzz K	75	VintMaple SR*X	115	Reggae SR*X	154	Industrial S	193	16"CoatedT3R
KICK OTHER		76	SolidMaple S	116	CrossStick1	155	Voice S	194	18"Coated T4
38	Tight K	77	SolidMapleSR*X	117	CrossStick2	156	TR808 S	195	18"CoatedT4R

Drum Instrument List

No.	Name	No.	Name	No.	Name	No.	Name	No.	Name
196	Beech T1	239	Brush T4	280	TR909 T1	320	16"Dark CrE	360	22"Clean RdB
197	Beech T2	240	10"PluggedT1	281	TR909 T2	321	18"Dark CrBw	361	20"Bright Rd
198	Beech T3	241	12"PluggedT2	282	TR909 T3	322	18"Dark CrE	362	20"BrightRdE
199	Beech T4	242	13"PluggedT3	283	TR909 T4	323	16"Thin CrBw	363	20"BrightRdB
200	Oyster T1	243	16"PluggedT4	284	Elec T1	324	16"Thin CrE	364	24"Heavy Rd
201	Oyster T2	244	Buzz T1	285	Elec T2	325	18"Thin CrBw	365	24"Heavy RdE
202	Oyster T3	245	Buzz T2	286	Elec T3	326	18"Thin CrE	366	24"Heavy RdB
203	Oyster T4	246	Buzz T3	287	Elec T4	327	16"PaperCrBw	367	20"Oldies Rd
204	Rose T1	247	Buzz T4	288	ElecBend T1	328	16"Paper CrE	368	20"OldiesRdE
205	Rose T2	248	Big T1	289	ElecBend T2	329	18"PaperCrBw	369	20"OldiesRdB
206	Rose T3	249	Big T2	290	ElecBend T3	330	18"Paper CrE	370	20"Sizzle Rd
207	Rose T4	250	Big T3	291	ElecBend T4	331	16"Fast CrBw	371	20"SizzleRdE
208	Vintage T1	251	Big T4	HI-HAT		332	16"Fast CrE	372	20"SizzleRdB
209	Vintage T2	252	TomRimClick1	292	Custom HH	333	18"Fast CrBw	373	20"Brush Rd
210	Vintage T3	253	TomRimClick2	293	Custom HHE	334	18"Fast CrE	374	20"Brush RdE
211	Vintage T4	254	TomRimClick3	294	Dark HH	335	16"PowerCrBw	375	20"Brush RdB
212	Booth T1	255	TomRimClick4	295	Dark HHE	336	16"Power CrE	376	18"Crash Rd
213	Booth T2	TOM OTHER		296	Oldies HH	337	18"PowerCrBw	377	18"Crash RdE
214	Booth T3	256	Gate T1	297	Oldies HHE	338	18"Power CrE	378	ShortTail Rd
215	Booth T4	257	Gate T2	298	Brush HH	339	16"Mallet Cr	379	ShortTailRdE
216	Dry T1	258	Gate T3	299	TambourineHH	340	16"Brush Cr	380	ShortTailRdB
217	Dry T2	259	Gate T4	300	TambourinHHE	341	18"Brush Cr	381	Lo-Fi Rd
218	Dry T3	260	Dirty T1	301	Clave HH	342	18"BrshSzlCr	382	Lo-Fi RdE
219	Dry T4	261	Dirty T2	302	Clave HHE	SPLASH/CHINA		383	Lo-Fi RdB
220	Fiber T1	262	Dirty T3	303	Club HH	343	10"Medium Sp	CYMBAL OTHER	
221	Fiber T2	263	Dirty T4	304	Club HHE	344	10"MediumSpE	384	Lo-Fi Cr
222	Fiber T3	264	Lo-Fi T1	305	Industry HH	345	10"Rude Sp	385	Sweep Cr
223	Fiber T4	265	Lo-Fi T2	306	Industry HHE	346	10"Rude SpE	386	Phase Cr
224	Slap T1	266	Lo-Fi T3	307	Lo-Fi HH	347	12"Thin Sp	387	Ambient Cr
225	Slap T2	267	Lo-Fi T4	308	Lo-Fi HHE	348	6"Cup	388	Reverse Cr
226	Slap T3	268	Jet T1	309	Jingle HH	349	18"Medium Ch	389	Reverse Ch
227	Slap T4	269	Jet T2	310	Jingle HHE	350	18"MediumChE	390	Reverse Rd
228	10"Roto T1	270	Jet T3	311	HandCym HH	351	20"Heavy Ch	391	Voice Cr
229	12"Roto T2	271	Jet T4	312	Voice HH	352	16"Swish	392	TR808 Cr
230	14"Roto T3	272	Voice T1	313	Voice HHE	353	19"PiggyBack	393	Elec Cr
231	19"Roto T4	273	Voice T2	314	TR808 HH	354	Piggy-Crash	PERCUSSION	
232	Oct T1	274	Voice T3	315	TR909 HH	RIDE		394	Bongo Hi
233	Oct T2	275	Voice T4	316	CR78 HH	355	20"Custom Rd	395	Bongo Lo
234	Oct T3	276	TR808 T1	317	Metal78 HH	356	20"CustomRdE	396	Conga Open
235	Oct T4	277	TR808 T2	318	Maracas HH	357	20"CustomRdB	397	Conga Mute
236	Brush T1	278	TR808 T3	CRASH		358	22"Clean Rd	398	Conga Slap
237	Brush T2	279	TR808 T4	319	16"Dark CrBw	359	22"Clean RdE	399	Conga Lo
238	Brush T3								

No.	Name	No.	Name	No.	Name	No.	Name
400	Timbale Hi	443	AfricaJingle	486	808Claves	527	AfroStomp
401	Timbale Rim	444	Bendir	487	808Conga	528	CarDoor
402	Timbale Lo	445	PotDrum	488	78Cowbell	529	RandomProp
403	TimbalePaila	446	PotDrum Mute	489	78Guiro	530	Bomb
404	Cajon Open	447	Tabla Na	490	78Maracas	531	Thunder
405	Cajon Slap	448	Tabla Te	491	78Tambourine	532	Laser
406	Cajon Bass	449	Tabla Ti	492	78Bongo	533	Martian
407	Cowbell1	450	Tabla Tin	493	78Claves	534	Nantoka!
408	Cowbell1 Tip	451	Tabla Tun	SOUND EFFECT			
409	Cowbell2	452	Baya Ge				
410	Cowbell3	453	Baya Gin	494	Sticks	535	Hoo...
411	Claves	454	Baya Ka	495	Click	536	Mystery
412	Maracas	455	Baya Slide	496	TekClick	537	Chemistry
413	Shaker	456	Sagat Mt/Op	497	Metro Click	538	OrchHit Maj
414	SmallShaker	457	TempleBell	498	Metro Bell	539	OrchHit Min
415	Tambourine1	458	TempleBlock	499	Beep	540	Reverse Bell
416	Tambourine2	459	Taiko	500	Pyon	541	Reverse Voco
417	Tambourine3	460	Wa-Daiko	501	Hi-Q	542	Voice-Yeah
418	Guiro Long	461	ConcertBD	502	MetalNoise	543	Voice-Ahhh
419	Guiro Short	462	ConcertBD Mt	503	MetalPhase	544	Voice-Haaa
420	RainStick	463	Timpani G	504	SuperLow	545	Voice-Dat
421	VibraSlap	464	Timpani C	505	Clap1	546	Voice-Doot
422	Quijada	465	HandCymbal	506	Clap2	547	Voice-Boom
423	Cabasa	466	HandCym Mute	507	HouseClap	548	Voice-Tun
424	Surdo Open	467	Castanet	508	BuzzClap	549	808Clap
425	Surdo Mute	468	WoodBlock Hi	509	NoizeClap	550	909Clap
426	SurdoL Mt/Op	469	WoodBlock Lo	510	MetalClap	551	78MBeat
427	PandeiroThmb	470	Triangle	511	MetalSlap	552	Sin 440Hz
428	PandeiroSlap	471	TrianglCl/Op	OFF			
429	PandeiroJngl	472	Crotale				
430	RepiniqueM/O	473	BellTree	512	Snaps	553	OFF
431	RepiniqueRim	474	Sleighbell	513	Snappin'		
432	Agogo Hi	475	TreeChimes	514	Scratch1		
433	Agogo Lo	476	TinyGong	515	Scratch2		
434	Whistle	477	Gong	516	Scratch3		
435	WhistleShort	478	SteelDrum	517	Stamp		
436	Caxixi	479	Glockenspiel	518	Ratchet		
437	Cuica Hi	480	Kalimba	519	AirDrive		
438	Cuica Lo	481	Marimba	520	Hammer		
439	Djembe	482	Vibraphone	521	Barrel		
440	Djembe Slap	483	808Cowbell1	522	TrashCan		
441	Djembe Bass	484	808Cowbell2	523	CoroCoro		
442	MetalCrasher	485	808Maracas	524	Bubbles		
				525	Punch		
				526	HeartBeat		

About Remarks

*X (Cross Stick):

When the XSTICK is turned ON, it makes possible to use both "Rim Shot" and "Cross Stick" on the rim.

About Kick Instruments

/M: When playing these sounds very hard, the result will be the same as when you leave the beater against the head of an acoustic bass drum.

About Snare/Tom Instruments

The last letter of each instrument name means the sound of head shot, or rim shot.

(Example)

S: head sound of Snare
SR: rim sound of Snare
T1: head sound of Tom 1
T1R: rim sound of Tom 1

About Cymbal Instruments

The last letter of each instrument name means the sound of bow shot, edge shot, or bell shot.

(Example)

HH: bow sound of hi-hat
HHE: edge sound of hi-hat
CrBw: bow sound of crash
CrE: edge sound of crash
Rd: bow sound of ride
RdB: bell sound of ride
RdE: edge sound of ride

Copyright

When you purchase the TD-9 percussion sound module from an authorized Roland dealer, the included sounds are licensed, not sold, to you by Roland Corporation, for commercial use in music production, public performance, broadcast, etc.

You may use any of the included sounds in a commercial or non-commercial recording without paying any additional license fees. However, you must strictly adhere to the following crediting guidelines on any music recording that utilize material from TD-9.

Reproduction or duplication of any of the sound contained in the TD-9, either as they exist on this sound module or by any means of reformatting, mixing, filtering, re-synthesizing, processing or otherwise editing for use in another product or for re-sale, is strictly prohibited without the express written consent of Roland. All unauthorized giving, trading, lending, renting, re-issue, re-distribution or re-sale of the sounds included in the TD-9 are expressly prohibited.

In Plain English: Be creative in your application of the TD-9 sounds, and keep this sounds for your use only. DO NOT COPY IT.

Preset Percussion Set List

Note No.	Name	Volume	Pan	Pitch	decay	Amb Send	CC
C-1 0	Tambourine1	100	CENTER	0	100	0	0
1	Tambourine2	100	CENTER	0	100	0	0
2	AfricaJingle	100	CENTER	0	100	0	0
3	MetalCrasher	100	CENTER	0	100	0	0
4	Bendir	100	CENTER	0	100	0	0
5	RainStick	100	CENTER	0	100	0	0
6	78Guiro	100	CENTER	0	100	0	0
7	78Tambourine	100	CENTER	0	100	0	0
8	808Clap	100	CENTER	0	100	0	0
9	808Cowbell1	100	CENTER	0	100	0	0
10	808Maracas	100	CENTER	0	100	0	0
11	909Clap	100	CENTER	0	100	0	0
C0 12	HI-Q	100	CENTER	0	100	0	0
13	MetalSlap	100	CENTER	0	100	0	0
14	Scratch1	100	CENTER	0	100	0	0
15	Scratch3	100	CENTER	0	100	0	0
16	Sticks	100	CENTER	0	100	0	0
17	Click	100	CENTER	0	100	0	0
18	Metro Click	100	CENTER	0	100	0	0
19	Metro Bell	100	CENTER	0	100	0	0
20	Clap1	100	CENTER	0	100	0	0
21	VibraSlap	100	CENTER	0	100	0	0
22	Custom HHE	100	CENTER	0	100	0	127
23	OFF	100	CENTER	0	100	0	0
C1 24	Beep	100	CENTER	0	100	0	0
25	Crotale	100	CENTER	0	100	0	0
26	Custom HHE	100	CENTER	0	100	0	0
27	16"Maple T4	100	CENTER	0	100	0	0
28	16"Maple T4R	100	CENTER	0	100	0	0
29	Guiro Short	100	CENTER	0	100	0	0
30	Guiro Long	100	CENTER	0	100	0	0
31	Cuica Hi	100	CENTER	0	100	0	0
32	Cuica Lo	100	CENTER	0	100	0	0
33	Cowbell1	100	CENTER	0	100	0	0
34	Cowbell2	100	CENTER	0	100	0	0
35	Custom K	100	CENTER	0	100	0	0
C2 36	Maple K	100	CENTER	0	100	0	0
37	CrossStick1	100	CENTER	0	100	0	0
38	Custom S	100	CENTER	0	100	0	0
39	16"Maple T4R	100	CENTER	0	100	0	0
40	Custom SR	100	CENTER	0	100	0	0
41	16"Maple T4	100	CENTER	0	100	0	0
42	Custom HH	100	CENTER	0	100	0	127
43	14"Maple T3	100	CENTER	0	100	0	0
44	Custom HHE	100	CENTER	0	100	0	80
45	12"Maple T2	100	CENTER	0	100	0	0
46	Custom HH	100	CENTER	0	100	0	0
47	12"Maple T2R	100	CENTER	0	100	0	0
C3 48	10"Maple T1	100	CENTER	0	100	0	0
49	16"Fast CrBw	100	CENTER	0	100	0	0
50	10"Maple T1R	100	CENTER	0	100	0	0
51	20"Custom Rd	100	CENTER	0	100	0	0
52	18"Power CrE	100	CENTER	0	100	0	0
53	20"CustomRdB	100	CENTER	0	100	0	0
54	Tambourine1	100	CENTER	0	100	0	0
55	16"Fast CrE	100	CENTER	0	100	0	0
56	Cowbell3	100	CENTER	0	100	0	0
57	18"PowerCrBw	100	CENTER	0	100	0	0
58	14"Maple T3R	100	CENTER	0	100	0	0
59	20"CustomRdE	100	CENTER	0	100	0	0

Note No.	Name	Volume	Pan	Pitch	decay	Amb Send	CC
C4 60	Bongo Hi	100	CENTER	0	100	0	0
61	Bongo Lo	100	CENTER	0	100	0	0
62	Conga Open	100	CENTER	0	100	0	0
63	Conga Slap	100	CENTER	0	100	0	0
64	Conga Lo	100	CENTER	0	100	0	0
65	Timbale Hi	100	CENTER	0	100	0	0
66	Timbale Lo	100	CENTER	0	100	0	0
67	Agogo Hi	100	CENTER	0	100	0	0
68	Agogo Lo	100	CENTER	0	100	0	0
69	Cabasa	100	CENTER	0	100	0	0
70	Maracas	100	CENTER	0	100	0	0
71	WhistleShort	100	CENTER	0	100	0	0
72	Whistle	100	CENTER	0	100	0	0
C5 73	Guiro Short	100	CENTER	0	100	0	0
74	Guiro Long	100	CENTER	0	100	0	0
75	Claves	100	CENTER	0	100	0	0
76	WoodBlock Hi	100	CENTER	0	100	0	0
77	WoodBlock Lo	100	CENTER	0	100	0	0
78	Cuica Hi	100	CENTER	0	100	0	0
79	Cuica Lo	100	CENTER	0	100	0	0
80	TrianglCI/Op	100	CENTER	0	100	0	0
81	Triangle	100	CENTER	0	100	0	0
82	Shaker	100	CENTER	0	100	0	0
83	Sleighbell	100	CENTER	0	100	0	0
C6 84	BellTree	100	CENTER	0	100	0	0
85	Castanet	100	CENTER	0	100	0	0
86	Surdo Mute	100	CENTER	0	100	0	0
87	Surdo Open	100	CENTER	0	100	0	0
88	RepiniqueRim	100	CENTER	0	100	0	0
89	RepiniqueM/O	100	CENTER	0	100	0	0
90	Conga Mute	100	CENTER	0	100	0	0
91	Conga Lo	100	CENTER	0	40	0	0
92	PandeiroJngl	100	CENTER	0	100	0	0
93	PandeiroThmb	100	CENTER	0	100	0	0
94	PandeiroSlap	100	CENTER	0	100	0	0
95	TreeChimes	100	CENTER	0	100	0	0
C7 96	Crotale	100	CENTER	0	100	0	0
97	Gong	100	CENTER	0	100	0	0
98	Cajon Bass	100	CENTER	0	100	0	0
99	Cajon Open	100	CENTER	0	100	0	0
100	Cajon Slap	100	CENTER	0	100	0	0
101	Cowbell1 Tip	100	CENTER	0	100	0	0
102	WoodBlock Hi	100	CENTER	0	100	0	0
103	Caxixi	100	CENTER	0	100	0	0
104	Timbale Rim	100	CENTER	0	100	0	0
105	TimbalePaila	100	CENTER	0	100	0	0
106	Cuica Hi	100	CENTER	0	100	0	0
107	Surdo Open	100	CENTER	0	100	0	0
C8 108	Surdo Mute	100	CENTER	0	100	0	0
109	PotDrum	100	CENTER	0	100	0	0
110	Quijada	100	CENTER	0	100	0	0
111	PotDrum Mute	100	CENTER	0	100	0	0
112	Djembe	100	CENTER	0	100	0	0
113	Djembe Slap	100	CENTER	0	100	0	0
114	Djembe Bass	100	CENTER	0	100	0	0
115	Taiko	100	CENTER	0	100	0	0
116	Wa-Daiko	100	CENTER	0	100	0	0
117	Tabla Na	100	CENTER	0	100	0	0
118	Tabla Te	100	CENTER	0	100	0	0
119	Tabla Ti	100	CENTER	0	100	0	0
C9 120	Tabla Tun	100	CENTER	0	100	0	0
121	Baya Ge	100	CENTER	0	100	0	0
122	Baya Gin	100	CENTER	0	100	0	0
123	Baya Ka	100	CENTER	0	100	0	0
124	Baya Slide	100	CENTER	0	100	0	0
125	ConcertBD	100	CENTER	0	100	0	0
126	HandCymbal	100	CENTER	0	100	0	0
127	OFF	100	CENTER	0	100	0	0

MIDI Implementation Chart

Function...	Transmitted	Recognized	Remarks
Basic Default Channel Changed	1-16, OFF 1-16, OFF	1-16, OFF 1-16, OFF	*1 Memorized
Mode Default Messages Altered	Mode 3 X *****	Mode 3 X *****	
Note Number : True Voice	0-127 *****	0-127 0-127	Memorized
Velocity Note On Note Off	<input type="radio"/> 9nH, v = 1-127 <input type="radio"/> 8nH, v = 64	<input type="radio"/> <input type="radio"/>	
After Key's Touch Channel's	<input type="radio"/> X	<input type="radio"/> X	
Pitch Bend	X	X	
Control Change	0, 32 <input type="radio"/> *2 1 <input type="radio"/> *3 4 <input type="radio"/> *3 16 <input type="radio"/> *3	<input type="radio"/> *2 <input type="radio"/> *3 <input type="radio"/> *3 <input type="radio"/> *3	Bank Select Modulation Foot Controller General Purpose Controller 1
Program Change : True Number	<input type="radio"/> 0-49 *****	<input type="radio"/> 0-49 0-49	*2 *4 Program No. 1-50 (fixed)
System Exclusive	<input type="radio"/>	<input type="radio"/>	Device ID = 17 (10H)
System : Song Position Common : Song Select : Tune Request	X X X	X X X	
System : Clock Real Time : Commands	X X	X X	
Aux : All Sound Off Messages : Reset All Controllers : Local On/Off : All Notes Off : Active Sensing : System Reset	X X X X <input type="radio"/> X	<input type="radio"/> (120) <input type="radio"/> <input type="radio"/> <input type="radio"/> (123-127) <input type="radio"/> X	
Notes	*1 The channel of percussion part is fixed at 11. *2 DRUM part only. *3 One is selected as the hi-hat control pedal. *4 O X is selectable.		

Mode 1 : OMNI ON, POLY
Mode 3 : OMNI OFF, POLY

Mode 2 : OMNI ON, MONO
Mode 4 : OMNI OFF, MONO

O : Yes
X : No

Specifications

TD-9: Percussion Sound Module

● Instruments

Drum Instruments: 522

● Drum Kits

50

● Instrument Parameters

KICK:

Head Tuning, Muffling

SNARE:

Head Tuning, Muffling

TOM:

Head Tuning, Muffling

HI-HAT:

Cymbal Size, Fixed Hi-Hat

CYMBAL:

Cymbal Size, Sustain

Others:

Pitch, Decay

● Effect Types

Ambience (9 Types)

2-Band Equalizer

● Ambience Parameters

Room Type, Room Size, Wall Type,
Mic Position, Room Shape

● Mixer Parameters

Volume, Pan

● Percussion Set

1

● Song

Preset Songs: 50

Parts: 4

Play Functions:

One shot, Loop, Repeat

Tempo: 20–300

● Quick Rec

Resolution: 480 ticks per quarter note

Recording Method: Real-time

Maximum Note Storage:

approx. 32,000 notes

● File Format

Audio File: WAV/MP3

● Display

64 x 128 dots Graphic Type LCD
(backlit LCD)

● Connectors

Trigger Input connector (DB-25 type)
(Kick, Snare, Tom1, Tom2, Tom3,
Hi-Hat, Crash1, Ride, Ride Bell,
Hi-Hat Control)

Extra Trigger Input Jacks: 2
(CRASH2,AUX)
(Stereo 1/4 inch phone type)

Output Jacks (L (MONO), R)
(Stereo 1/4 inch phone type)

Phones Jack
(Stereo 1/4 inch phone type)

Mix in Jack
(stereo miniature phone type)

MIDI Connectors (IN, OUT/THRU)

USB Connector (for USB memory key)

● Output Impedance

1.0 k Ω

● Power Supply

AC Adaptor (DC 9 V)

● Current Draw

500 mA

● Dimensions

160 (W) x 88.5 (D) x 259.5 (H) mm
6-5/16 (W) x 3-1/2 (D) x 10-1/4 (H)
inches

● Weight

850 g / 1 lb 14 oz
(excluding AC Adaptor)

● Accessories

Owner's Manual

Quick Start

AC Adaptor (PSB-1U)

Special Connection Cable

Wing Bolt (M5 x 10) x 2

Sound Module Mounting Plate

● Options

Pads:

PD series, PDX series

Cymbals:

CY series

Kick Triggers: KD series

Hi-Hats: VH-11

Hi-Hat Control Pedal: FD-8

Stand: MDS- seriee

Cymbal Mount: MDY series

Pad Mount: MDH series

Acoustic Drum Trigger:
RT-10K, RT-10S, RT-10T

Personal Drum Monitor:
PM-10, PM-30

V-Drums Accessory Package: DAP-3

V-Drums Mat: TDM-20, TDM-10

* In the interest of product improvement, the specifications and/or appearance of this unit are subject to change without prior notice.

Drum Kit

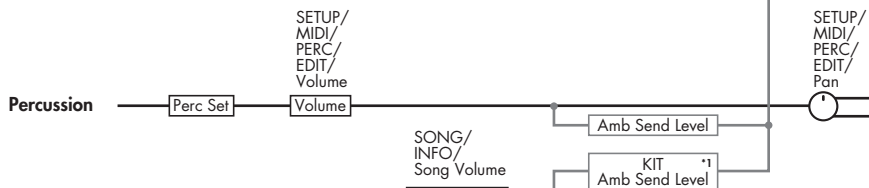
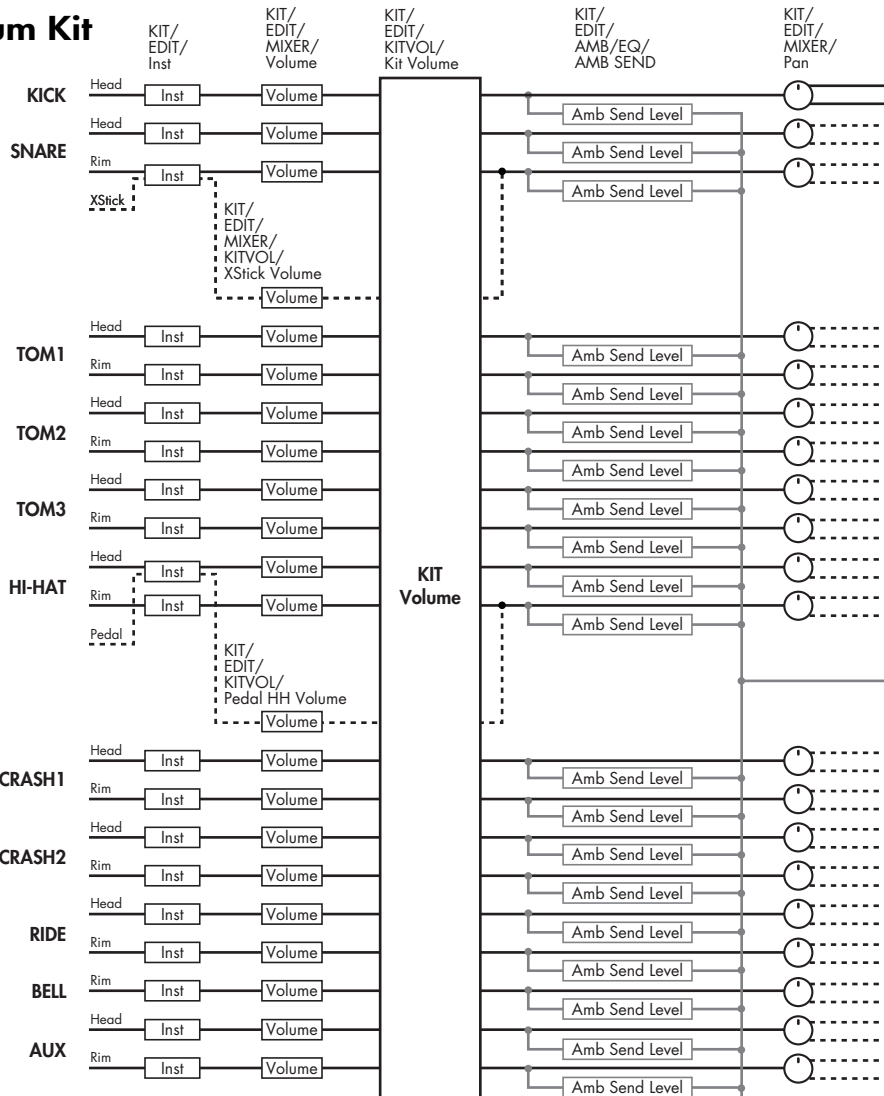

*1 The settings of the currently selected drum kit are used.

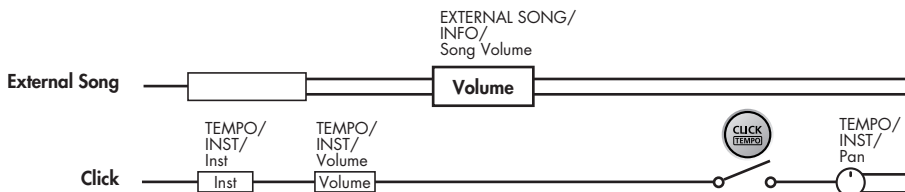

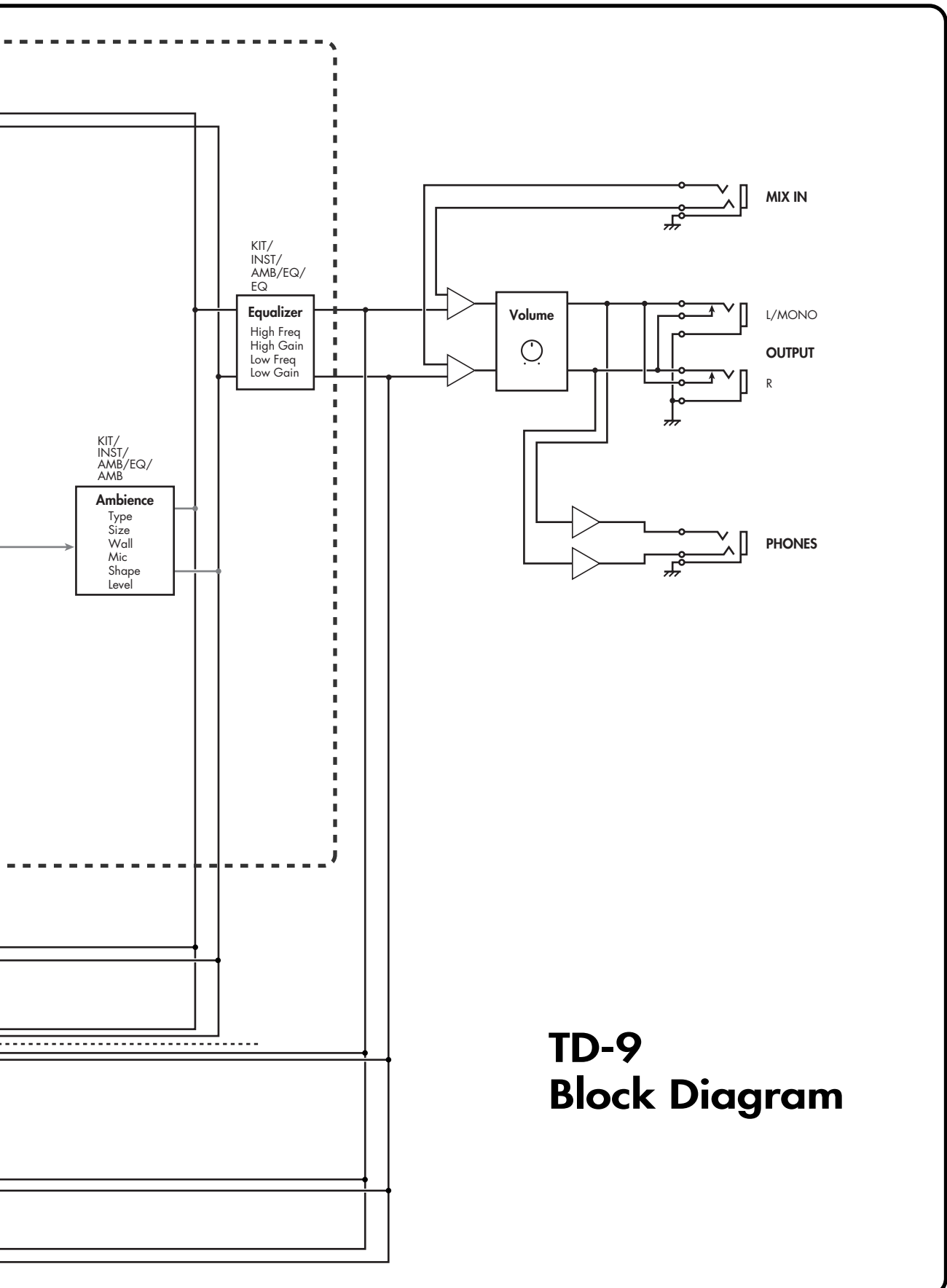

TD-9 Block Diagram

Index

Symbols

+/- 13–14

A

A 37
Advanced Trigger Parameters 48
AMB 28
Amb Send Level 54
AMB/EQ 28
Ambience 28
AMBIENCE SEND 28
Audio Files 34–35
AUX 13

B

B 37
Basic Trigger Parameters 47
Bass Part 34, 36
Bell Shot 23
Block Diagram 74
Bow Shot 23–24

C

CC 54
CHAR 29, 56–57
Choking 24
CLICK (TEMPO) 13, 40
Closed Hi-Hat 24
Copy 30–31
Copying
 Drum Kit 30
 Instrument 31
Count In Play 40
CRASH2 13
Cross Stick 22–23
Crosstalk 49
Cursor 14
Cursor Buttons (◀/▶/▲/▼) ... 12, 14
Curve 47
Cymbal Size 26

D

DC IN 13
Decay 26, 54
Default Trigger Type 61

DELETE 29, 56–57
Deleting
 Backup data 59
 Quick Rec data 59
Display Contrast 15, 55
DRUM 36
Drum Instrument 67
DRUM KIT 22
Drum Kit 22
Drum Part 34, 36

E

Edge Shot 23–24
EQ 28
Equalizer 28
EXIT 13
EXTERNAL SONG 35

F

Factory Reset 60
Fixed Hi-Hat 26
Formatting
 USB Memory Key 60
Function Buttons (F1/F2/F3) 12, 14

G

Group 25

H

Head Tuning 25–26
HH Closed (Bow) 32
HH Closed (Edge) 32
HH Compatibility 53
HH Note# Border 53
HH Open (Bow) 32
HH Open (Edge) 32
HH Pedal 32
High Freq 28
High Gain 28
Hi-Hat Type 49

I

INSERT 29, 56–57
INST 25
Inst 25, 40

Instrument 25, 54
Interval 40

K

KIT 13
Kit Volume 27

L

LCD Contrast 55
Length 37
Level 28
Loading
 Backup data 58
 Quick Rec data 58
Local Control 52
LOOP 37
Low Freq 28
Low Gain 28

M

Mask Time 49
Mesh Pad 19
Metronome 15, 40
Metronome's sound 40
Mic 28
MIDI 32, 51, 72
MIDI IN 13
MIDI OUT/THRU 13
MIX IN 13, 38
MIXER 27
Muffling 25–26
MUTE 12
Mute 36

N

Name 37
Naming
 Backup name 56
 Drum Kit 29
 Quick Rec data 57
Note Chase 51
NOTE NUMBER 32
Note Number 71

O

ONESHOT	37
Open Hi-Hat	24
OTHERS	36
Others Part	34, 36
OUTPUT	13

P

Pad Switch	55
PAN	27
Pan	40, 54
PD-105	19
PD-85	19
Pedal HH Volume	27
PedalCC	53
PERC	36
Percussion Instruments	54
Percussion Part	34, 36
Percussion Set	54
PHONES	13
Pitch	26, 54
▶/■	12
Playback	
Quick Rec data	42
Song	15, 35
Playing	
Quick Rec data	42
Song	35
POWER	12
Preview	15
Preview Velocity	55

Q

QUICK PLAY	12
Quick Play	41
QUICK REC	12
Quick Rec	41
Quick Rec Click	40

R

Repeat	37
Retrig Cancel	48
Rim Gain	49
Rim Shot	23
RimShot Adj	49
Rx PC	51

S

Save	14
Saving	
Backup data	56
Quick Rec data	57
Saving your settings	14
SCOPE	13
Scope	43
SEND	28
Sensitivity	47
SETUP	13
Shape	28
SHIFT	13
Size	28
Soft Thru	52
SONG	12
Song Information	37
Song Settings	37
Song Volume	37
Sustain	26
Switch	28

T

Tempo	36–37, 40
Threshold	47
Time Signature	37, 40
Total Time	37
TRIG TYPE	46
Trig Type	47–48
TRIGGER IN	13
TRIGGER INPUT	13
Trigger Type	46
Tx PC	51
Tx/Rx Channel	51
Type	28, 37

U

USB	13
USB Memory Key	7, 13, 34–35, 56

V

VALUE Dial	13
VALUE dial	14
VH-11	50
VOLUME	12, 27
Volume	40, 54

W

Wall	28
------------	----

X

XSTICK	22–23
Xstick	32
XStick Threshold	27
XStick Volume	27
XTalk Cancel	49

Z

ZOOM -	43
ZOOM +	43

Information

When you need repair service, call your nearest Roland Service Center or authorized Roland distributor in your country as shown below.

AFRICA

EGYPT

Al Fanny Trading Office
9, EBN Hagar Al Askalany Street,
ARD E1 Golf, Heliopolis,
Cairo 11341, EGYPT
TEL: (022)-417-1828

REUNION

MARCEL FO-YAM Sarl
25 Rue Jules Hermann,
Chaudron - BP79 97 491
Ste Clotilde Cedex,
REUNION ISLAND
TEL: (0262) 218-429

SOUTH AFRICA

T.O.M.S. Sound & Music (Pty)Ltd.
2 ASTRON ROAD DENVER
JOHANNESBURG ZA 2195,
SOUTH AFRICA
TEL: (011) 417 3400

Paul Bothner(PTY)Ltd.

Royal Cape Park, Unit 24
Londonderry Road, Ottery 7800
Cape Town, SOUTH AFRICA
TEL: (021) 799 4900

ASIA

CHINA

Roland Shanghai Electronics

Co.,Ltd.
5F, No.1500 Pingliang Road
Shanghai 200090, CHINA
TEL: (021) 5580-0800

Roland Shanghai Electronics

Co.,Ltd. (BEIJING OFFICE)
3F, Soluxe Fortune Building
63 West Dawang Road, Chaoyang
District, Beijing, CHINA
TEL: (010) 5960-2565

HONG KONG

Tom Lee Music
11/F Silvercord Tower 1
30 Canton Rd
Tsimshatsui, Kowloon,
HONG KONG
TEL: 852-2737-7688

Parsons Music Ltd.

8th Floor, Railway Plaza, 39
Chatham Road South, T.S.T,
Kowloon, HONG KONG
TEL: 852-2333-1863

INDIA

Rivera Digitech (India) Pvt. Ltd.
411, Nirman Kendra Mahalaxmi
Flats Compound Off. Dr. Edwin
Moses Road, Mumbai-400011,
INDIA
TEL: (022) 2493 9051

INDONESIA

PT. Citra Intirama
Ruko Garden Shopping Arcade
Unit 8 CR, Podomoro City
Jl.Letjend. S.Perman Kav.28
Jakarta Barat 11470, INDONESIA
TEL: (021) 5698-5519/5520

KOREA

Cosmos Corporation
1461-9, Seocho-Dong,
Seocho Ku, Seoul, KOREA
TEL: (02) 3486-8855

MALAYSIA/ SINGAPORE

Roland Asia Pacific Sdn. Bhd.
45-1, Block C2, Jalan PJU 1/39,
Dataran Prima, 47301 Petaling
Jaya, Selangor, MALAYSIA
TEL: (03) 7805-3263

PHILIPPINES

G.A. Yupangco & Co. Inc.
339 Gil J. Puyat Avenue
Makati, Metro Manila 1200,
PHILIPPINES
TEL: (02) 899 9801

TAIWAN

**ROLAND TAIWAN ENTERPRISE
CO., LTD.**
9F-5, No. 112 Chung Shan
North Road Sec. 2 Taipei 104,
TAIWAN R.O.C.
TEL: (02) 2561 3339

THAILAND

Theera Music Co., Ltd.
100-108 Soi Vergn Nakornkasem,
New Road,Sumpantawong,
Bangkok 10100, THAILAND
TEL: (02) 224-8821

VIET NAM

VIET THUONG CORPORATION
386 CACH MANG THANG TAM ST.
DIST.3, HO CHI MINH CITY,
VIET NAM
TEL: (08) 9316540

OCEANIA

AUSTRALIA/ NEW ZEALAND

**Roland Corporation
Australia Pty.,Ltd.**
38 Campbell Avenue
Dee Why West. NSW 2099,
AUSTRALIA

For Australia
TEL: (02) 9982 8266
For New Zealand
TEL: (09) 3098 715

CENTRAL/LATIN AMERICA

ARGENTINA

Instrumentos Musicales S.A.
Av.Santa Fe 2055
1123 Buenos Aires, ARGENTINA
TEL: (011) 4508-2700

BARBADOS

A&B Music Supplies LTD
12 Webster Industrial Park
Wildely, St.Michael, BARBADOS
TEL: (246) 430-1100

BRAZIL

Roland Brasil Ltda.
Rua San Jose, 211
Parque Industrial San Jose
Cotia - Sao Paulo - SP, BRAZIL
TEL: (011) 4615 5666

CHILE

Comercial Fancy II S.A.
Rut: 96.919.420-1
Nataníel Cox #739, 4th Floor
Santiago - Centro, CHILE
TEL: (02) 688-9540

COLOMBIA

Centro Musical Ltda.
Cra 43 B No 25 A 41 Bododega 9
Medellin, COLOMBIA
TEL: (574) 3812529

COSTA RICA

**JUAN Bansbach Instrumentos
Musicales**
Ave.1. Calle 11, Apartado 10237,
San Jose, COSTA RICA
TEL: 258-0211

CURACAO

Zeelandia Music Center Inc.
Orionweg 30
Curacao, Netherland Antilles
TEL: (305) 5926866

DOMINICAN REPUBLIC

Instrumentos Fernando Giraldez
Calle Proyecto Central No.3
Ens.La Esperilla,
Santo Domingo,
DOMINICAN REPUBLIC
TEL: (809) 683 0305

ECUADOR

Mas Musica
Rumichaca 822 y Zaruma
Guayaquil - ECUADOR
TEL: (593-4) 2302364

EL SALVADOR OMNI MUSIC

75 Avenida Norte y Final Alameda
Juan Pablo II,
Edificio No.4010 San Salvador,
EL SALVADOR
TEL: 262-0788

GUATEMALA

Causa Instrumental
Calleza Roosevelt 34-01,zona 11
Ciudad de Guatemala,
GUATEMALA
TEL: (502) 599-2888

HONDURAS

Almacen Pajaro Azul S.A. de C.V.
B.O.Paz Barahona
3 Ave.11 Calle S.O
San Pedro Sula, HONDURAS
TEL: (504) 553-2029

MARTINIQUE

**Musique & Son
Z.L.Les Mangle**
97232 Le Lamentin,
MARTINIQUE F.W.I.
TEL: 596 596 426860

Gigamus SARL

10 Rte De La Folle
97200 Fort De France
MARTINIQUE F.W.I.
TEL: 596 596 715222

MEXICO

Casa Veerkamp, s.a. de c.v.
Av. Toluca No. 323, Col. Olivar
de los Padres 01780 Mexico D.F.,
MEXICO
TEL: (55) 5668-6699

NICARAGUA

**Bansbach Instrumentos
Musicales Nicaragua**
Altamira D'Este Calle Principal
de la Farmacia Sta.Avenida
1 Cuadra al Lago.#503
Managua, NICARAGUA
TEL: (505) 277-2557

PANAMA

SUPRO MUNDIAL, S.A.
Boulevard Andrews, Albrook,
Panama City, REP. DE PANAMA
TEL: 315-0101

PARAGUAY

**Distribuidora De Instrumentos
Musicales**
J.E. Olear y ESQ, Manduvira
Asuncion, PARAGUAY
TEL: (595) 21 492147

PERU

Audionet
Distribuciones Musicales SAC
Juan Fanning 530
Miraflores
Lima - PERU
TEL: (511) 4461388

TRINIDAD

AMR Ltd
Ground Floor
Maritime Plaza
Barataria TRINIDAD W.I.
TEL: (868) 638 6385

URUGUAY

Todo Musica S.A.
Francisco Acuna de Figueroa
1771
C.P.: 11.800
Montevideo, URUGUAY
TEL: (02) 924-2335

VENEZUELA

**Instrumentos Musicales
Allegro, C.A.**
Av.Las Industrials edf.Guitar import
#7 zona Industrial de Turumo
Caracas, VENEZUELA
TEL: (212) 244-1122

EUROPE

BELGIUM/FRANCE/ HOLLAND/ LUXEMBOURG

Roland Central Europe N.V.
Houtstraat 3, B-2260, Oevel
(Westerlo) BELGIUM
TEL: (014) 575811

CROATIA

ART-CENTAR
Degenova 3.
HR - 10000 Zagreb, CROATIA
TEL: (1) 466 8493

CZECH REP.

**CZECH REPUBLIC DISTRIBUTOR
s.r.o**
Votárova 247/16
180 00 Praha 8, CZECH REP.
TEL: (2) 830 20270

DENMARK

Roland Scandinavia A/S
Skagerakvej 7 Postbox 880
DK-2100 Copenhagen,
DENMARK
TEL: 3916 6200

FINLAND

**Roland Scandinavia As, Filial
Finland**
Vanha Nurmjarventie 62
01670 Vantaa, FINLAND
TEL: (0) 9 68 24 020

GERMANY/AUSTRIA

**Roland Elektronische
Musikinstrumente HmbH.**
Oststrasse 96, 22844 Norderstedt,
GERMANY
TEL: (040) 52 60090

GREECE/CYPRUS

STOLLAS S.A.
Music Sound Light
155, New National Road
Patras 26442, GREECE
TEL: 2610 435400

HUNGARY

Roland East Europe Ltd.
2045, Törökbalint, FSD Park 3. ép.,
HUNGARY
TEL: (23) 511011

IRELAND

Roland Ireland
E2 Calmount Park, Calmount
Avenue, Dublin 12,
Republic of IRELAND
TEL: (01) 4294444

ITALY

Roland Italy S. p. a.
Viale delle Industrie 8,
20020 Arese, Milano, ITALY
TEL: (02) 937-78300

NORWAY

Roland Scandinavia Amd.
Kontor Norge
Lilleakerveien 2 Postboks 95
Lilleaker N-0216 Oslo,
NORWAY
TEL: 2273 0074

POLAND

ROLAND POLSKA SP. Z O.O.
ul. Kty Grodziskie 16B
03-289 Warszawa, POLAND
TEL: (022) 678 9512

PORTUGAL

Roland Systems Group EMEA, S.L.
Branch Office Porto
Edificio Tower Plaza
Rotunda Eng. Edgar Cardoso
23, 9ºG
4400-676 Vila Nova de Gaia,
PORTUGAL
TEL: (+351) 22 608 00 60

ROMANIA

FBS LINES
Piata Libertatii 1,
535500 Gheorgheni, ROMANIA
TEL: (266) 364 609

RUSSIA

Roland Music LLC
Dorozhnaya ul.3,korp.6
117 545 Moscow, RUSSIA
TEL: (495) 981-4967

SERBIA

Music AP Ltd.
Sutjeska br. 5 XS - 24413 Palic,
SERBIA
TEL: (024) 539 395

SLOVAKIA

DAN Acoustic s.r.o.
Povazská 18.
SK - 940 01 Nové Zámky,
SLOVAKIA
TEL: (035) 6424 330

SPAIN

Roland Systems Group EMEA, S.L.
Paseo Garcia Faria, 33-35
08005 Barcelona, SPAIN
TEL: 93 493 91 00

SWEDEN

**Roland Scandinavia A/S
SWEDISH SALES OFFICE**
Mårbackagatan 31, 4 tr.
SE-123 43 Farsta, SWEDEN
TEL: (0) 8 683 04 30

SWITZERLAND

Roland (Switzerland) AG
Landstrasse 5, Postfach,
CH-4452 Itingen, SWITZERLAND
TEL: (061) 975-9987

UKRAINE

EURHYTHMICS Ltd.
P.O.Box: 37-a
Nedecy Str. 30
UA - 89600 Mukachevo, UKRAINE
TEL: (03131) 414-40

UNITED KINGDOM

Roland (U.K.) Ltd.
Atlantic Close, SWANSEA SA7 9FJ,
UNITED KINGDOM
TEL: (01792) 702701

MIDDLE EAST

BAHRAIN

Moon Stores
No.1231&1249 Rumaytha
Building Road 3931,
Manama 339, BAHRAIN
TEL: 17 813 942

IRAN

MOCO INC.
Jadeh Makhsous Karaj (K-9),
Nakhe Zarin Ave.
Jalal Street, Reza Alley No.4
Tehran 1389716791, IRAN
TEL: (021)-44545370-5

ISRAEL

**Halilit P. Greenspoon & Sons
Ltd.**
8 Retzif Ha'alia Hashnia St.
Tel-Aviv-Yafo ISRAEL
TEL: (03) 6823666

JORDAN

MUSIC HOUSE CO. LT.D.
FREDDY FOR MUSIC
P. O. Box 922846
Amman 11192, JORDAN
TEL: (06) 5692696

KUWAIT

**EASA HUSAIN AL-YOUSIFI &
SONS CO.**
Al-Yousifi Service Center
P.O.Box 126 (Safat) 13002,
KUWAIT
TEL: 00 965 802929

LEBANON

Chahine S.A.L.
George Zeidan St., Chahine Bldg.,
Achrafieh, P.O.Box: 16-5857
Beirut, LEBANON
TEL: (01) 20-1441

OMAN

TALENTZ CENTRE L.L.C.
Malatan House No.1
Al Noor Street, Ruwi
SULTANATE OF OMAN
TEL: 2478 3443

QATAR

**AL-EMADITRADING &
CONTRACTING CO.**
P.O. Box 62, Doha, QATAR
TEL: 4423-554

SAUDI ARABIA

**aDawiah Universal Electronics
APL**
Prince Pizza Inn
Behind Turkey Street
aDawiah Building,
PO BOX 2154,
Alkhubar 31952,
SAUDI ARABIA
TEL: (03) 8643601

SYRIA

Technical Light & Sound Center
PO Box 13520 Bldg No.49
Khaled Abn Alwalid St.
Damascus, SYRIA
TEL: (011) 223-5384

TURKEY

ZUHAL DIS TICARET A.S.
Galip Dede Cad. No.33
Beyoglu, Istanbul, TURKEY
TEL: (0212) 249 85 10

U.A.E.

**Zak Electronics & Musical
Instruments Co. L.L.C.**
Zabeel Road, Al Sherqoq Bldg.,
No. 14, Ground Floor, Dubai,
U.A.E.
TEL: (04) 3360715

NORTH AMERICA

CANADA

Roland Canada Ltd.
(Head Office)
5480 Parkwood Way Richmond B.
C., V6V 2M4, CANADA
TEL: (604) 270 6626

Roland Canada Ltd.

(Toronto Office)
170 Admiral Boulevard
Mississauga On L5N 2N6,
CANADA
TEL: (905) 362 9707

U. S. A.

Roland Corporation U.S.
5100 S. Eastern Avenue
Los Angeles, CA 90040-2938,
U. S. A.
TEL: (323) 890 3700

For EU Countries



- UK** This symbol indicates that in EU countries, this product must be collected separately from household waste, as defined in each region. Products bearing this symbol must not be discarded together with household waste.
- DE** Dieses Symbol bedeutet, dass dieses Produkt in EU-Ländern getrennt vom Hausmüll gesammelt werden muss gemäß den regionalen Bestimmungen. Mit diesem Symbol gekennzeichnete Produkte dürfen nicht zusammen mit den Hausmüll entsorgt werden.
- FR** Ce symbole indique que dans les pays de l'Union européenne, ce produit doit être collecté séparément des ordures ménagères selon les directives en vigueur dans chacun de ces pays. Les produits portant ce symbole ne doivent pas être mis au rebut avec les ordures ménagères.
- IT** Questo simbolo indica che nei paesi della Comunità europea questo prodotto deve essere smaltito separatamente dai normali rifiuti domestici, secondo la legislazione in vigore in ciascun paese. I prodotti che riportano questo simbolo non devono essere smaltiti insieme ai rifiuti domestici. Ai sensi dell'art. 13 del D.Lgs. 25 luglio 2005 n. 151.
- ES** Este símbolo indica que en los países de la Unión Europea este producto debe recogerse aparte de los residuos domésticos, tal como este regulado en cada zona. Los productos con este símbolo no se deben depositar con los residuos domésticos.
- PT** Este símbolo indica que nos países da UE, a recolha deste produto deverá ser feita separadamente do lixo doméstico, de acordo com os regulamentos de cada região. Os produtos que apresentem este símbolo não deverão ser eliminados juntamente com o lixo doméstico.
- NL** Dit symbool geeft aan dat in landen van de EU dit product gescheiden van huishoudelijk afval moet worden aangeboden, zoals bepaald per gemeente of regio. Producten die van dit symbool zijn voorzien, mogen niet samen met huishoudelijk afval worden verwijderd.
- DK** Dette symbol angiver, at i EU-lande skal dette produkt opsamlles adskilt fra husholdningsaffald, som defineret i hver enkelt region. Produkter med dette symbol må ikke smides ud sammen med husholdningsaffald.
- NO** Dette symbolet indikerer at produktet må behandles som spesialavfall i EU-land, iht. til retningslinjer for den enkelte regionen, og ikke kastes sammen med vanlig husholdningsavfall. Produkter som er merket med dette symbolet, må ikke kastes sammen med vanlig husholdningsavfall.
- SE** Symbolen anger att i EU-länder måste den här produkten kasseras separat från hushållsavfall, i enlighet med varje regions bestämmelser. Produkter med den här symbolen får inte kasseras tillsammans med hushållsavfall.
- FI** Tämä merkintä ilmaisee, että tuote on EU-maissa kerättävä erillään kotitalousjätteistä kunakin alueen voimassa olevien määräysten mukaisesti. Tällä merkinnällä varustettuja tuotteita ei saa hävittää kotitalousjätteiden mukana.
- HU** Ez a szimbólum azt jelenti, hogy az Európai Unióban ezt a terméket a háztartási hulladéktól elkülönítve, az adott régióban érvényes szabályozás szerint kell gyűjteni. Az ezzel a szimbóllal ellátott termékeket nem szabad a háztartási hulladék közé dobni.
- PL** Symbol oznacza, że zgodnie z regulacjami w odpowiednim regionie, w krajach UE produktu nie należy wyrzucać z odpadami domowymi. Produktów opatrzonych tym symbolem nie można utylizować razem z odpadami domowymi.
- CZ** Tento symbol udává, že v zemích EU musí být tento výrobek sbírán odděleně od domácího odpadu, jak je určeno pro každý region. Výrobky nesoucí tento symbol se nesmí vyhazovat spolu s domácím odpadem.
- SK** Tento symbol vyjadruje, že v krajinách EÚ sa musí zber tohto produktu vykonávať oddelene od domového odpadu, podľa nariadení platných v konkrétnej krajine. Produkty s týmto symbolom sa nesmú vyhazovať spolu s domovým odpadom.
- EE** See sümbol näitab, et EL-i maades tuleb see toode olempürgist eraldi koguda, nii nagu on igas piirkonnas määratletud. Selle sümboliga märgitud tooteid ei tohi ära visata koos olmeprügiga.
- LT** Šis simbolis rodo, kad ES šalyse šis produktas turi būti surenkamas atskirai nuo buitinių atliekų, kaip nustatyta kiekviename regione. Šiuo simboliu paženklinoti produktai neturi būti išmetami kartu su buitinių atliekomis.
- LV** Šis simbols norāda, ka ES valstīs šo produktu jāievāc atsevišķi no mājsaimniecības atkritumiem, kā noteikts katrā reģionā. Produkts ar šo simbolu nedrīkst izmest kopā ar mājsaimniecības atkritumiem.
- SI** Ta simbol označuje, da je treba proizvod v državah EU zbirati ločeno od gospodinskih odpadkov, tako kot je določeno v vsaki regiji. Proizvoda s tem znakom ni dovoljeno odlagati skupaj z gospodinskimi odpadki.
- GR** Το σύμβολο αυτό υποδηλώνει ότι στις χώρες της Ε.Ε. το συγκεκριμένο προϊόν πρέπει να συλλέγεται χωριστά από τα υπόλοιπα οικιακά απορρίμματα, σύμφωνα με όσα προβλέπονται σε κάθε περιοχή. Τα προϊόντα που φέρουν το συγκεκριμένο σύμβολο δεν πρέπει να απορρίπτονται μαζί με τα οικιακά απορρίμματα.

For China

有关产品中所含有害物质的说明

本资料就本公司产品中所含的特定有害物质及其安全性予以说明。

本资料适用于 2007 年 3 月 1 日以后本公司所制造的产品。

环保使用期限



此标志适用于在中国国内销售的电子信息产品，表示环保使用期限的年数。所谓环保使用期限是指在自制造日起的规定的期限内，产品中所含的有害物质不致引起环境污染，不会对人身、财产造成严重的不良影响。环保使用期限仅在遵照产品使用说明书，正确使用产品的条件下才有效。不当的使用，将会导致有害物质泄漏的危险。

产品中有毒有害物质或元素的名称及含量

部件名称	有毒有害物质或元素					
	铅(Pb)	汞(Hg)	镉(Cd)	六价铬(Cr(VI))	多溴联苯(PBB)	多溴二苯醚(PBDE)
外壳(壳体)	×	○	○	○	○	○
电子部件(印刷电路板等)	×	○	×	○	○	○
附件(电源线、交流适配器等)	×	○	○	○	○	○

○：表示该有毒有害物质在该部件所有均质材料中的含量均在 SJ/T11363-2006 标准规定的限量要求以下。

×：表示该有毒有害物质至少在该部件的某一均质材料中的含量超出 SJ/T11363-2006 标准规定的限量要求。

因根据现有的技术水平，还没有什么物质能够代替它。

