

Panasonic®

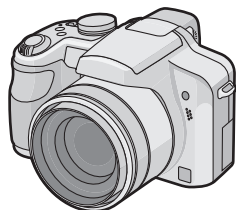

Basic Operating Instructions

Digital Camera

Model No. **DMC-FZ28**



Before use, please read these instructions completely.



Please also refer to **Operating Instructions (PDF format)** recorded on the CD-ROM containing the **Operating Instructions (supplied)**.



You can learn about advanced operation methods and check the Troubleshooting.

Dear Customer,

We would like to take this opportunity to thank you for purchasing this Panasonic Digital Camera. Please read these Operating Instructions carefully and keep them handy for future reference.

Information for Your Safety

WARNING:

- TO REDUCE THE RISK OF FIRE, ELECTRIC SHOCK OR PRODUCT DAMAGE,**
- **DO NOT EXPOSE THIS APPARATUS TO RAIN, MOISTURE, DRIPPING OR SPLASHING AND THAT NO OBJECTS FILLED WITH LIQUIDS, SUCH AS VASES, SHALL BE PLACED ON THE APPARATUS.**
 - **USE ONLY THE RECOMMENDED ACCESSORIES.**
 - **DO NOT REMOVE THE COVER (OR BACK); THERE ARE NO USER SERVICEABLE PARTS INSIDE. REFER SERVICING TO QUALIFIED SERVICE PERSONNEL.**

Carefully observe copyright laws.

Recording of pre-recorded tapes or discs or other published or broadcast material for purposes other than your own private use may infringe copyright laws. Even for the purpose of private use, recording of certain material may be restricted.

- Please note that the actual controls and components, menu items, etc. of your Digital Camera may look somewhat different from those shown in the illustrations in these Operating Instructions.
- SDHC Logo is a trademark.
- Microsoft product screen shot(s) reprinted with permission from Microsoft Corporation.
- Other names, company names, and product names printed in these instructions are trademarks or registered trademarks of the companies concerned.

THE SOCKET OUTLET SHALL BE INSTALLED NEAR THE EQUIPMENT AND SHALL BE EASILY ACCESSIBLE.

CAUTION

Danger of explosion if battery is incorrectly replaced. Replace only with the same or equivalent type recommended by the manufacturer. Dispose of used batteries according to the manufacturer's instructions.

Warning

Risk of fire, explosion and burns. Do not disassemble, heat above 60 °C or incinerate.

Product Identification Marking is located on the bottom of units.

-If you see this symbol-

Information on Disposal in other Countries outside the European Union

This symbol is only valid in the European Union.

If you wish to discard this product, please contact your local authorities or dealer and ask for the correct method of disposal.



■ About the battery charger

CAUTION!

- DO NOT INSTALL OR PLACE THIS UNIT IN A BOOKCASE, BUILT-IN CABINET OR IN ANOTHER CONFINED SPACE. ENSURE THE UNIT IS WELL VENTILATED. TO PREVENT RISK OF ELECTRIC SHOCK OR FIRE HAZARD DUE TO OVERHEATING, ENSURE THAT CURTAINS AND ANY OTHER MATERIALS DO NOT OBSTRUCT THE VENTILATION VENTS.
- DO NOT OBSTRUCT THE UNIT'S VENTILATION OPENINGS WITH NEWSPAPERS, TABLECLOTHS, CURTAINS, AND SIMILAR ITEMS.
- DO NOT PLACE SOURCES OF NAKED FLAMES, SUCH AS LIGHTED CANDLES, ON THE UNIT.
- DISPOSE OF BATTERIES IN AN ENVIRONMENTALLY FRIENDLY MANNER.

- The battery charger is in the standby condition when the AC power is supplied. The primary circuit is always "live" as long as the battery charger is connected to an electrical outlet.

■ About the battery pack

- Do not heat or expose to flame.
- Do not leave the battery(ies) in an automobile exposed to direct sunlight for a long period of time with doors and windows closed.

■ Cautions for Use

- Do not use any other AV cables except the supplied one.
- Do not use any other cables except a genuine Panasonic component cable (DMW-HDC2; optional).

Keep the camera as far away as possible from electromagnetic equipment (such as microwave ovens, TVs, video games etc.).

- If you use the camera on top of or near a TV, the pictures and sound on the camera may be disrupted by electromagnetic wave radiation.
- Do not use the camera near cell phones because doing so may result in noise adversely affecting the pictures and sound.
- Recorded data may be damaged, or pictures may be distorted, by strong magnetic fields created by speakers or large motors.
- Electromagnetic wave radiation generated by microprocessors may adversely affect the camera, disturbing the pictures and sound.
- If the camera is adversely affected by electromagnetic equipment and stops functioning properly, turn the camera off and remove the battery or disconnect AC adaptor (DMW-AC7PP; optional). Then reinsert the battery or reconnect AC adaptor and turn the camera on.

Do not use the camera near radio transmitters or high-voltage lines.

- If you record near radio transmitters or high-voltage lines, the recorded pictures and sound may be adversely affected.

■ Care of the camera

- **Do not strongly shake or bump the camera by dropping it etc.**

This unit may malfunction, recording pictures may no longer be possible or the lens or the LCD monitor may be damaged.

- Retract the lens before carrying the camera or playing back pictures.
- **Be particularly careful in the following places as they may cause this unit to malfunction.**
 - Places with a lot of sand or dust.
 - Places where water can come into contact with this unit such as when using it on a rainy day or on a beach.
- **Do not touch the lens or the sockets with dirty hands. Also, be careful not to allow liquids, sand and other foreign matter to get into the space around the lens, buttons etc.**
- **If water or seawater splashes on the camera, use a dry cloth to wipe the camera body carefully.**

■ About Condensation (When the lens or the Viewfinder is fogged up)

- Condensation occurs when the ambient temperature or humidity changes. Be careful of condensation since it causes lens stains, fungus and camera malfunction.
- If condensation occurs, turn the camera off and leave it for about 2 hours. The fog will disappear naturally when the temperature of the camera becomes close to the ambient temperature.

■ About cards that can be used in this unit

You can use an SD Memory Card, an SDHC Memory Card and a MultiMediaCard.

- When the term **card** is used in these operating instructions this refers to the following types of Memory Cards.
 - SD Memory Card (8 MB to 2 GB)
 - SDHC Memory Card (4 GB, 8 GB, 16 GB, 32 GB)
 - MultiMediaCard (still pictures only)

More specific information about memory cards that can be used with this unit.

- You can only use an SDHC Memory Card if using cards with 4 GB or more capacity.
- A 4 GB (or more) Memory Card without an SDHC logo is not based on the SD Standard and will not work in this product.

Please confirm the latest information on the following website.

<http://panasonic.co.jp/pavc/global/cs>

(This Site is English only.)

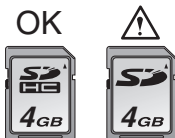

- Keep the Memory Card out of reach of children to prevent swallowing.







Contents

Information for Your Safety	2
Standard Accessories	6
Names of the Components	7
Charging the Battery	10
About the Battery (charging/number of recordable pictures)	11
Inserting and Removing the Card (optional)/the Battery	12
Setting Date/Time (Clock Set)	13
• Changing the clock setting	13
Setting the Menu	14
• Setting menu items	15
• Using the quick menu	16
Selecting the [REC] Mode	17
Taking pictures using the automatic function	
(A): Intelligent Auto Mode)	19
• Scene detection	20
• AF Tracking Function	20
Taking pictures with your favourite settings	
(P: Programme AE mode)	21
• Focusing	21
Taking Pictures with the Zoom	22
• Using the Optical Zoom/Using the Extra Optical Zoom (EZ)/ Using the Digital Zoom	22
Playing back Pictures ([NORMAL PLAY])	23
Deleting Pictures	24
• To delete a single picture	24
• To delete multiple pictures (up to 50) or all the pictures	24
Connecting to a PC	25
Reading the Operating Instructions (PDF format)	27
Specifications	28
Useful Information	31

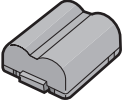
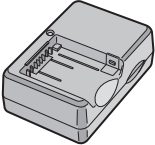
Standard Accessories

Check that all the accessories are included before using the camera.

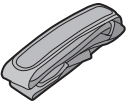
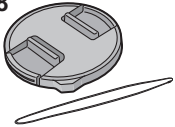
- 1 Battery Pack
(Indicated as **battery** in the text)
Charge the battery before use.
 - 2 Battery Charger
(Indicated as **charger** in the text)
 - 3 USB Connection Cable
 - 4 AV Cable
 - 5 CD-ROM
 - Software:
Use it to install the software to your PC.
 - 6 CD-ROM
 - Operating Instructions
 - 7 Shoulder Strap
 - 8 Lens Cap/Lens Cap String
 - 9 Lens Hood
Black
 - 10 Hood Adaptor
- SD Memory Card, SDHC Memory Card and MultiMediaCard are indicated as **card** in the text.
 - **The card is optional.**
You can record or play back pictures on the built-in memory when you are not using a card.
 - Consult the dealer or your nearest Service Centre if you lose the supplied accessories. (You can purchase the accessories separately.)

1  CGR-S006E	2  DE-A43B
3  K1HA08CD0019	4  K1HA08CD0020
5 	6  VFF0433
7  VFC4269	8  VYK2U93
9  VYQ4122	10  VYQ4124

Names of the Components

- 1 Lens
- 2 Flash
- 3 Self-timer indicator
AF assist lamp
- 4 Microphone

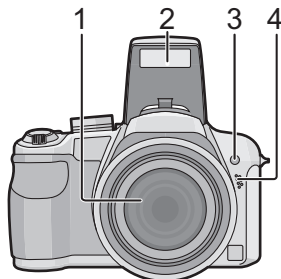

- 5 Flash open button
- 6 Diopter adjustment dial
- 7 Viewfinder
- 8 Speaker
- 9 [EVF/LCD] button
- 10 [AF/AE LOCK] button
- 11 Joystick

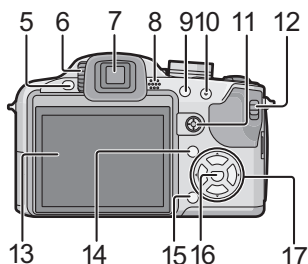

The joystick is operated in two different ways: it can be moved in the up, down, left and right directions to perform an operation, or it can be pressed to select. In these operating instructions, it is pictured as shown in the figure below or described with ▲/▼/◀/▶.

Example: When the joystick is moved toward ◀ (left)
Place your finger on the right side of the joystick, and move the joystick toward the left.



or Move ◀

Push the joystick straight in.

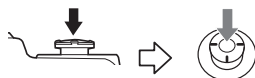

or Press

- 12 [REC]/[PLAYBACK] selector switch
- 13 LCD monitor
- 14 [DISPLAY] button
- 15 Delete button/
Single or burst mode button
- 16 [MENU/SET] button
- 17 Cursor buttons

- ◀/Self-timer button
- ▼/Function button

Assign [REC] Mode Menu to ▼ button. It is convenient to register [REC] Mode Menu that is used often.

[REVIEW]/[SENSITIVITY]/[WHITE BALANCE]/[METERING MODE]/[AF MODE]/
[I.EXPOSURE]

- ▶/Flash setting button

- ▲/Exposure compensation/

Auto bracket/Colour bracket/Flash output adjustment

In these operating instructions, the cursor buttons are described as shown in the figure below or described with ▲/▼/◀/▶.
e.g.: When you press the ▼ (down) button

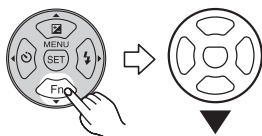

or

Press ▼

- 18 Zoom lever
- 19 Shutter button
- 20 [AF/FOCUS] button
- 21 Mode dial
- 22 Camera ON/OFF switch
- 23 Power lamp
- 24 [AF/MF] button

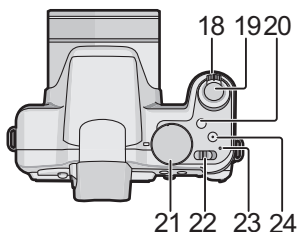

25 Strap eyelet

- Be sure to attach the strap when using the camera to ensure that you will not drop it.

26 [DIGITAL/AV OUT] socket

27 [DC IN] socket

- Always use a genuine Panasonic AC adaptor (DMW-AC7PP; optional).
- This camera cannot charge the battery even when the AC adaptor (DMW-AC7PP; optional) is connected to it.

28 Terminal door

29 Lens barrel

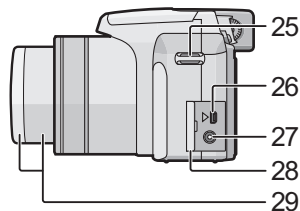

30 [COMPONENT OUT] socket

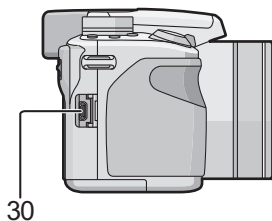

31 Card/Battery door

32 Tripod receptacle

- When you use a tripod, make sure the tripod is stable when the camera is attached to it.

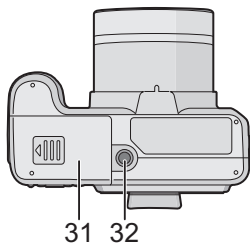

Charging the Battery

- Use the dedicated charger and battery.
- The battery is not charged when the camera is shipped. Charge the battery before use.
- Charge the battery with the charger indoors.
- Charge the battery in a temperature between 10 °C to 35 °C. (The battery temperature should also be the same.)

- 1 Attach the battery with attention to the direction of the battery.**

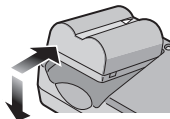

- 2 Connect the charger to the electrical outlet.**

- Charging starts when the [CHARGE] indicator (A) lights green.

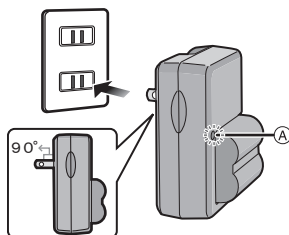

- 3 Detach the battery after charging is completed.**

- Charging is complete when the [CHARGE] indicator (A) turns off (after approx. 120 min maximum).

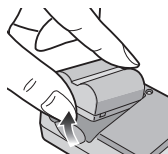

Note

- After charging is completed, be sure to disconnect the power supply device from the electrical outlet.
- The battery becomes warm after using it and during and after charging. The camera also becomes warm during use. This is not a malfunction.
- The battery will be exhausted if left for a long period of time after being charged.
- The battery can be recharged even when it still has some charge left, but it is not recommended that the battery charge be frequently topped up while the battery is fully charged. (The battery has characteristics that will reduce its operating duration and cause the battery to swell up.)
- When the operating time of the camera becomes extremely short even after properly charging the battery, the life of the battery may have expired. Buy a new battery.
- **Do not leave any metal items (such as clips) near the contact areas of the power plug. Otherwise, a fire and/or electric shocks may be caused by short-circuiting or the resulting heat generated.**

About the Battery (charging/number of recordable pictures)

■ The battery life

Number of recordable pictures	Approx. 460 pictures	(By CIPA standard in programme AE mode)
Recording time	Approx. 230 min	

Recording conditions by CIPA standard

- CIPA is an abbreviation of [Camera & Imaging Products Association].
 - Temperature: 23 °C/Humidity: 50% when LCD monitor is on.*
 - Using a Panasonic SD Memory Card (32 MB).
 - Using the supplied battery.
 - Starting recording 30 seconds after the camera is turned on. (When the optical image stabilizer function is set to [AUTO].)
 - **Recording once every 30 seconds** with full flash every second recording.
 - Rotating the zoom lever from Tele to Wide or vice versa in every recording.
 - Turning the camera off every 10 recordings and leaving it until the temperature of the battery decreases.
- * The number of recordable pictures decreases in Auto power LCD mode, Power LCD mode and High angle mode.

The number of recordable pictures varies depending on the recording interval time. If the recording interval time becomes longer, the number of recordable pictures decreases.

[e.g. When recording once every 2 minutes, the number of recordable pictures decreases to about 115.]

■ When using the viewfinder

Number of recordable pictures	Approx. 480 pictures (Approx. 240 min)	(By CIPA standard in programme AE mode)
--------------------------------------	---	---

■ Playback time when using the LCD monitor

Playback time	Approx. 480 min
----------------------	------------------------

The number of recordable pictures and playback time will vary depending on the operating conditions and storing condition of the battery.

■ Charging

Charging time	Approx. 120 min maximum
----------------------	--------------------------------

Charging time and **number of recordable pictures** with the optional battery pack (CGR-S006E) are the same as above.

The charging time will vary slightly depending on the status of the battery and the conditions in the charging environment.

When the charging has been completed successfully, the [CHARGE] indicator turns off.

Note

- The battery may swell and its operating time may become shorter as the number of times it is charged increases. For long term battery use, we recommend you do not frequently charge the battery before it is exhausted.
- The performance of the battery may temporarily deteriorate and the operating time may become shorter in low temperature conditions (e.g. skiing/snowboarding).

Inserting and Removing the Card (optional)/the Battery

- Check that this unit is turned off.
- Close the flash.
- We recommend using a Panasonic card.

1 Slide the card/battery door to open it.

- Always use genuine Panasonic batteries (CGR-S006E).
- If you use other batteries, we cannot guarantee the quality of this product.

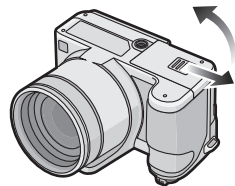

2 Battery: Insert it fully being careful about the direction you insert it. Pull the lever (A) in the direction of the arrow to remove the battery.

Card: Push it fully until it clicks being careful about the direction you insert it. To remove the card, push the card until it clicks, then pull the card out upright.

- (B): Do not touch the connection terminals of the card.
- The card may be damaged if it is not fully inserted.

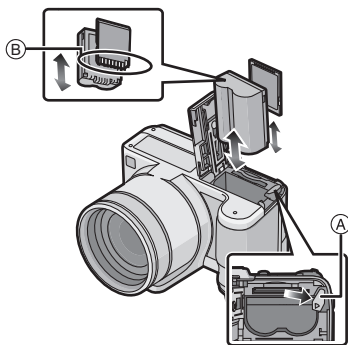

3 1: Close the card/battery door.

2: Slide the card/battery door to the end and then close it firmly.

- If the card/battery door cannot be completely closed, remove the card, check its direction and then insert it again.

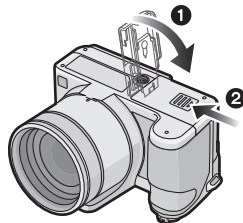

Note

- Remove the battery after use.
- Do not remove the battery while the power is on as the settings on the camera may not be stored properly.
- The supplied battery is designed only for the camera. Do not use it with any other equipment.
- Before removing the card or battery, turn the camera off, and wait until the power lamp has gone off completely.
(Otherwise, this unit may no longer operate normally and the card itself may be damaged or the recorded pictures may be lost.)

Setting Date/Time (Clock Set)

- The clock is not set when the camera is shipped.

1 Turn the camera on.

- (A) [MENU/SET] button
- (B) Cursor buttons

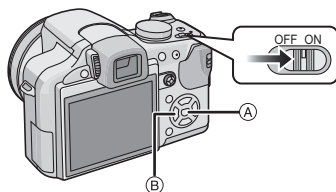

2 Press [MENU/SET].

3 Press ▲/▼ to select the language, and press [MENU/SET].

- The [PLEASE SET THE CLOCK] message appears. (This message does not appear in [PLAYBACK] mode.)

4 Press [MENU/SET].

5 Press ◀/▶ to select the items (year, month, day, hour, minute, display sequence or time display format), and press ▲/▼ to set.

- (A): Time at the home area
- (B): Time at the travel destination
- ⏏: Cancel without setting the clock.
- Select either [24HRS] or [AM/PM] for the time display format.
- AM/PM is displayed when [AM/PM] is selected.

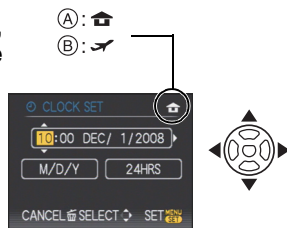

6 Press [MENU/SET] to set.

- After completing the clock settings, turn the camera off. Then turn the camera back on, switch to recording mode, and check that the display reflects the settings that were performed.
- When [MENU/SET] has been pressed to complete the settings without the clock having been set, set the clock correctly by following the "Changing the clock setting" procedure below.

Changing the clock setting

Select [CLOCK SET] in the [REC] or [SETUP] menu, and press ▶.

- It can be changed in steps 5 and 6 to set the clock.
- The clock setting is maintained for 3 months using the built-in clock battery even without the battery. (Leave the charged battery in the unit for 24 hours to charge the built-in battery.)

Setting the Menu

The camera comes with menus that allow you to set the settings for taking pictures and playing them back just as you like and menus that enable you to have more fun with the camera and use it more easily.

In particular, the [SETUP] menu contains some important settings relating to the camera's clock and power. Check the settings of this menu before proceeding to use the camera.

[MODE] playback mode menu

- This menu lets you select the setting of the playback methods such as playback or slide show of only the pictures set as [FAVORITE].

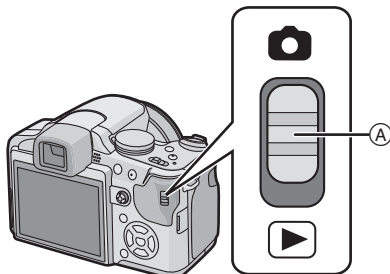
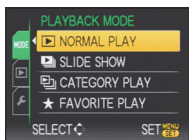

A [REC]/[PLAYBACK] selector switch

[PLAYBACK] mode menu

- This menu lets you make the rotation, protection, trimming or DPOF settings, etc. of recorded pictures.

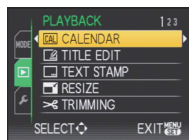

[REC] mode menu

- This menu lets you set the colouring, sensitivity, aspect ratio, number of pixels and other aspects of the pictures you are recording.



[SETUP] menu

- This menu lets you perform the clock settings, select the operating beep tone settings and set other settings which make it easier for you to operate the camera.
- The [SETUP] menu can be set from either the [REC MODE] or [PLAYBACK MODE].

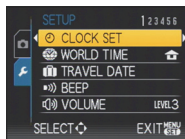

Setting menu items

This section describes how to select the programme AE mode settings, and the same setting can be used for the [PLAYBACK] menu and [SETUP] menu as well.

Example: Setting [AF MODE] from [□] to [⊗] in the programme AE mode

• ▲/▼/◀/▶ in the steps can be operated with the joystick too.

1 Turn the camera on.

- A [MENU/SET] button
- B [REC]/[PLAYBACK] selector switch
- C Mode dial

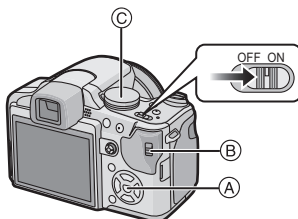

2 Slide the [REC]/[PLAYBACK] selector switch to [📺].

- When selecting the [PLAYBACK] mode menu settings, set the [REC]/[PLAYBACK] selector switch to [▶], and proceed to step 4.

3 Set the mode dial to [P].

4 Press [MENU/SET] to display the menu.

- You can switch menu screens from any menu item by rotating the zoom lever.



Switching to the [SETUP] menu

1 Press ◀.



2 Press ▼ to select the [SETUP] menu icon [⚙].

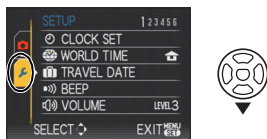

3 Press ▶.

- Select a menu item next and set it.

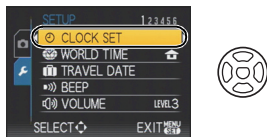

5 Press ▲/▼ to select [AF MODE].

- Select the item at the very bottom, and press ▼ to move to the second screen.



6 Press ►.

- Depending on the item, its setting may not appear or it may be displayed in a different way.



7 Press ▲/▼ to select [Q.MENU].



8 Press [MENU/SET] to set.



9 Press [MENU/SET] to close the menu.

Using the quick menu

By using the quick menu, some of the menu settings can be easily found.

- Some of the menu items cannot be set by the modes.

1 Press and hold down the joystick in recording mode until the [Q.MENU] is displayed

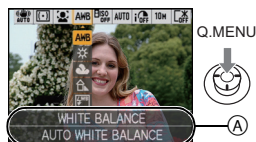

2 Press ▲/▼/◀/▶ to select the menu item and the setting and then press [MENU/SET] to close the menu.

- Ⓐ The items to be set and the settings are displayed.
- You can set the following items in detail by pressing [DISPLAY].
[WHITE BALANCE]/[AF MODE]/[STABILIZER]

Selecting the [REC] Mode

When the [REC] mode is selected, the camera can be set to the Intelligent auto mode in which the optimal settings are established in line with the subject to be recorded and the recording conditions, or to the scene mode which enables you to take pictures that match the scene being recorded.

- 1 Turn the camera on.
 (A) [REC]/[PLAYBACK] selector switch

- 2 Slide the [REC]/[PLAYBACK] selector switch to .

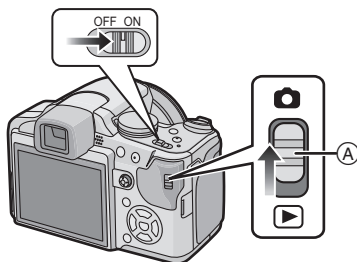

- 3 Switching the mode by rotating the mode dial.

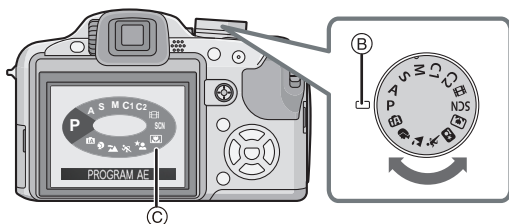

Align a desired mode with part (B).

- Rotate the mode dial slowly and surely to adjust to each mode. (The mode dial rotates 360°)

The screen (C) is displayed on the LCD monitor/Viewfinder when the mode dial is turned.

■ Basic

Intelligent auto mode

The subjects are recorded using settings automatically selected by the camera.

Programme AE mode

The subjects are recorded using your own settings.

■ Advanced

Aperture-priority AE mode

The shutter speed is automatically determined by the aperture value you set.

Shutter-priority AE mode

The aperture value is automatically determined by the shutter speed you set.

Manual exposure mode

The exposure is adjusted by the aperture value and the shutter speed which are manually adjusted.

C1 C2 Custom mode

Use this mode to take pictures with previously registered settings.

Motion picture mode

This mode allows you to record motion pictures.

SCN Scene mode

This allows you to take pictures that match the scene being recorded.

■ Advanced scene mode

Portrait mode

Use this mode to take pictures of people.

Scenery mode

Use this mode to take pictures of scenery.

Sports mode

Use this mode to take pictures of sporting events, etc.

Night portrait mode

Use this mode to take pictures of night scenes and people with night time scenery.

Close-up mode

Use this mode to take picture of close-by subject.

[REC] mode: **IA**

Taking pictures using the automatic function

(**IA**: Intelligent Auto Mode)

The camera will set the most appropriate settings to match the subject and the recording conditions so we recommend this mode for beginners or those who want to leave the settings to the camera and take pictures easily.

- The following functions are activated automatically.
 - Scene detection/[STABILIZER]/[INTELLIGENT ISO]/Face detection/[QUICK AF]/[EXPOSURE] (Intelligent Exposure)/Digital Red-eye Correction/Backlight Compensation

• The power lamp **3** lights when you turn this unit on

2. (It turns off after about 1 second.)

1: Shutter button)

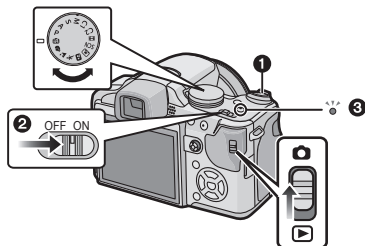

1 Slide the [REC]/[PLAYBACK] selector switch to **[CAMERA]**.

2 Set the mode dial to **[IA]**.

3 Hold this unit gently with both hands, keep your arms still at your side and stand with your feet slightly apart.

(A) AF assist lamp

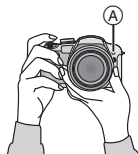

4 Press the shutter button halfway to focus.

- The focus indication **1** (green) lights when the subject is focused.
- The AF area **2** is displayed around the subject's face by the face detection function. In other cases, it is displayed at the point on the subject which is in focus.
- The focus range is 1 cm (Wide)/2 m (Tele) to ∞ . (Tele-macro function: 1 m to ∞)

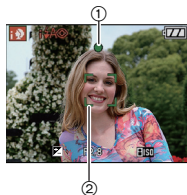







5 Press the shutter button fully (push it in further), and take the picture.

- The access indication lights red when pictures are being recorded on the built-in memory (or the card).



Scene detection

When the camera identifies the optimum scene, the icon of the scene concerned is displayed in blue for 2 seconds, after which its colour changes to the usual red.

 →  [i- PORTRAIT]	
 [i- SCENERY]	
 [i- CLOSE-UP]	
 [i- NIGHT PORTRAIT]	• Only when [4A] is selected
 [i- NIGHT SCENERY]	• Only when [4D] is selected

- [iA] is set if none of the scenes are applicable, and the standard settings are set.
- If a tripod is used, for instance, and the camera has judged that camera shake is minimal when the scene mode has been identified as [iA], the shutter speed will be set to a maximum of 8 seconds. Take care not to move the camera while taking pictures.
- An optimum scene for the specified subject will be chosen when set to AF tracking.

■ Face detection

When [iA] or [iA] is selected, the camera automatically detects a person's face, and it will adjust the focus and exposure.

Note

- Due to conditions such as the ones below, a different scene may be identified for the same subject.
 - Subject conditions: When the face is bright or dark, The size of the subject, The distance to the subject, The contrast of the subject, When the subject is moving, When zoom is used
 - Recording conditions: Sunset, Sunrise, Under low brightness conditions, When the camera is shaken
- To take pictures in an intended scene, it is recommended that you take pictures in the appropriate recording mode.

■ The Backlight Compensation

Backlight refers to when light comes from the back of a subject.

In this case, the subject will become dark, so this function compensates the backlight by brightening the whole of the picture automatically.

AF Tracking Function

It is possible to set the focus to the specified subject. Focus will keep following the subject automatically even if it moves.

- Set the [AF TRACKING] in the [REC] mode menu to [ON].
([AF TRACKING] is displayed on the screen.)

Bring the subject to the AF tracking frame, and press [AF/AE LOCK] to lock the subject.

- AF tracking frame will turn yellow.
- An optimum scene for the specified subject will be chosen.
- Press [AF/AE LOCK] again to release.



[REC] mode: **P**

Taking pictures with your favourite settings

(**P**: Programme AE mode)

Many more menu items can be set and you can take pictures with greater freedom than when you take pictures in the Intelligent auto mode.

- 1 Slide the [REC]/[PLAYBACK] selector switch to [P].**
 - (A) Mode dial
 - (B) [REC]/[PLAYBACK] selector switch
- 2 Set the mode dial to [P].**
- 3 Aim the AF area at the point you want to focus on.**

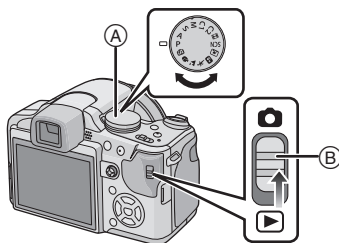

- 4 Press the shutter button halfway to focus.**
 - The focus range is 30 cm (Wide)/2 m (Tele) to ∞.



- 5 Press the halfway pressed shutter button fully to take a picture.**
 - The access indication lights red when pictures are being recorded on the built-in memory (or the card).



Focusing

Aim the AF area at the subject, and then press the shutter button halfway.



Focus	When the subject is focused	When the subject is not focused
Focus indication	On	Blinks
AF area	White → Green	White → Red
Sound	Beeps 2 times	Beeps 4 times

- (A) Focus indication
- (B) AF area (normal)
- (C) AF area (when using the digital zoom or when it is dark)
- (D) Recording distance range display (when zooming)

Taking Pictures with the Zoom

Using the Optical Zoom/Using the Extra Optical Zoom (EZ)/Using the Digital Zoom

You can zoom-in to make people and objects appear closer or zoom-out to record landscapes in wide angle. To make subjects appear even closer [maximum of 32.1×], do not set the picture size to the highest setting for each aspect ratio (**4:3/3:2/16:9**). Even higher levels of magnification are possible when [DIGITAL ZOOM] is set to [ON] in [REC] menu.

To make subjects appear closer use (Tele)

Rotate the zoom lever towards Tele.



To make subjects appear further away use (Wide)

Rotate the zoom lever towards Wide.



■ Types of zooms

Feature	Optical zoom	Extra optical zoom (EZ)	Digital zoom
Maximum magnification	18×	32.1×*	72× [including optical zoom 18×] 128× [including extra optical zoom 32.1×]
Picture quality	No deterioration	No deterioration	The higher the magnification level, the greater the deterioration.
Conditions	None	[PICTURE SIZE] with is selected.	[DIGITAL ZOOM] on the [REC] menu is set to [ON].
Screen display		 A [EZ] is displayed.	 B The digital zoom range is displayed. The AF area becomes larger when the shutter button is pressed halfway in the digital zoom range.

* The magnification level differs depending on [PICTURE SIZE] and [ASPECT RATIO] setting.

[PLAYBACK] mode: 

Playing back Pictures ([NORMAL PLAY])

1 Slide the [REC]/[PLAYBACK] selector switch ^(A) to .

- Normal playback is set automatically in the following cases.
 - When the mode was switched from the [REC] to [PLAYBACK].
 - When the camera was turned on while the [REC]/[PLAYBACK] selector switch was at .

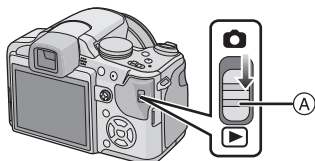

2 Press to select the picture.

- ^(A) File number
- ^(B) Picture number

: Play back the previous picture

: Play back the next picture

- Speed of picture forwarding/rewinding changes depending on the playback status.

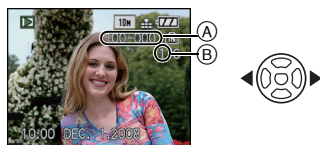





■ Fast forwarding/Fast rewinding

Press and hold   during playback.

: Fast rewind

: Fast forward

- The file number ^(A) and the picture number ^(B) only change one by one. Release   when the number of the desired picture appears to play back the picture.
- If you keep pressing  , the number of pictures forwarded/rewound increases.

[PLAYBACK] mode: 

Deleting Pictures

Once deleted, pictures cannot be recovered.

- Pictures on the built-in memory or the card, which is being played back will be deleted.

To delete a single picture

- 1 Select the picture to be deleted, and then press .

- (A) [DISPLAY] button
- (B)  button

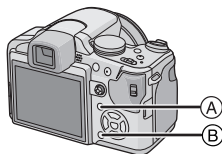

- 2 Press  to select [YES] and then press [MENU/SET].



To delete multiple pictures (up to 50) or all the pictures

- 1 Press .

- 2 Press / to select [DELETE MULTI] or [DELETE ALL] and then press [MENU/SET].

- [DELETE ALL] → step 5.

- 3 Press /// to select the picture, and then press [DISPLAY] to set. (Repeat this step.)

-  appears on the selected pictures. If [DISPLAY] is pressed again, the setting is cancelled.

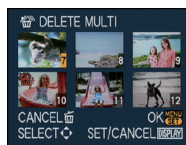

- 4 Press [MENU/SET].

- 5 Press  to select [YES] and then press [MENU/SET] to set.

Connecting to a PC

You can acquire recorded pictures to a PC by connecting the camera and the PC.

- You can easily print out or mail the pictures you have imported. Use of the “PHOTOfunSTUDIO-viewer-” bundled software on the CD-ROM (supplied) is a convenient way of doing this.
- Read the separate operating instructions for the supplied software for more information about the software in the CD-ROM (supplied) and how to install it.

Preparations:

Turn on the camera and the PC.

Remove the card before using the pictures in the built-in memory.

1 Connect the camera to a PC via the USB connection cable (A) (supplied).

- Do not use any other USB connection cables except the supplied one. Use of cables other than the supplied USB connection cable may cause malfunction.

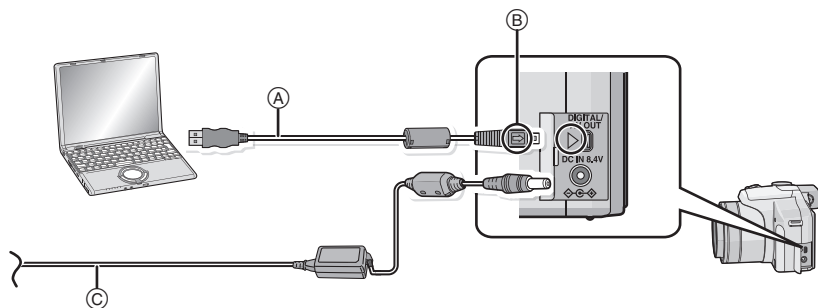

(A) USB connection cable (supplied)

- Check the directions of the connectors, and plug them straight in or unplug them straight out. (Otherwise the connectors may be bent out of shape which will cause trouble.)

(B) Align the marks, and insert.

(C) AC adaptor (DMW-AC7PP; optional)

- Use a battery with sufficient battery power or the AC adaptor (DMW-AC7PP; optional). If the remaining battery power becomes low during USB connection, the alarm beeps. Refer to “Disconnecting the USB connection cable safely” before disconnecting the USB connection cable. Otherwise, data may be destroyed.

2 Press ▲/▼ to select [PC], and then press [MENU/SET].

- If [USB MODE] is set to [PC] in the [SETUP] menu in advance, the camera will be automatically connected to the PC without displaying the [USB MODE] selection screen. Since there is no need to set this each time you connect to the PC, it is convenient.
- When the camera has been connected to the PC with [USB MODE] set to [PictBridge(PTP)], a message may appear on the PC's screen. Select [Cancel] to close the screen, and disconnect the camera from the PC. Then set [USB MODE] to [PC] again.

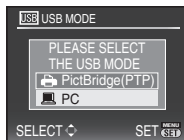

3 Double-click on [Removable Disk] in [My Computer].

- When using a Macintosh, the drive is displayed on the desktop. ("LUMIX", "NO_NAME" or "Untitled" is displayed.)

4 Double-click [DCIM] folder.

5 Using a drag-and-drop operation, move the pictures you want to acquire or the folder storing those pictures to any different folder on the PC.

■ Disconnecting the USB connection cable safely

- Proceed with the hardware removal using "Safely Remove Hardware" on the task tray of the PC. If the icon is not displayed, check that [ACCESS] is not displayed on the LCD monitor of the digital camera before removing the hardware.

Reading the Operating Instructions (PDF format)

- You have practised the basic operations introduced in these operating instructions and want to progress to advanced operations.
- You want to check the Troubleshooting.

In these kinds of situations refer to Operating Instructions (PDF format) recorded on the CD-ROM containing the Operating Instructions (supplied).

■ For Windows

1 Turn the PC on and insert the CD-ROM containing the Operating Instructions (supplied).

2 Select the desired language and then click [Operating Instructions] to install.

(Example: When an English language OS)

3 Double click the “FZ28 Operating Instructions” shortcut icon on the desktop.

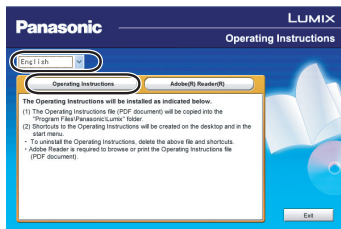

■ When the Operating Instructions (PDF format) will not open

You will need Adobe Acrobat Reader 4.0 or later to browse or print the Operating Instructions (PDF format).

Download and install a version of Adobe Reader that you can use with your OS from the following Web Site.

http://www.adobe.com/products/acrobat/readstep2_allversions.html

■ To uninstall the Operating Instructions (PDF format)

Delete the PDF file from the “Program Files\Panasonic\Lumix\” folder.

- When the contents in the Program Files folder cannot be displayed, click the [Show the contents of this folder] to display them.

■ For Macintosh

1 Turn the PC on and insert the CD-ROM containing the Operating Instructions (supplied).

2 Open the “Manual” folder in “VFF0433” and then copy the PDF file with the desired language inside the folder.

3 Double click the PDF file to open it.

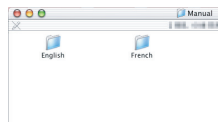

Specifications

Digital Camera: Information for your safety

Power Source:	DC 8.4 V
Power Consumption:	1.3 W (When recording with LCD Monitor) 1.2 W (When recording with Viewfinder) 0.6 W (When playing back with LCD Monitor) 0.5 W (When playing back with Viewfinder)

Camera effective pixels: 10,100,000 pixels

Image sensor: 1/2.33" CCD, total pixel number 10,700,000 pixels, Primary colour filter

Lens: Optical 18×zoom, f=4.8 mm to 86.4 mm (35 mm film camera equivalent: 27 mm to 486 mm)/F2.8 to F4.4

Digital zoom: Max. 4×

Extra optical zoom: Max. 32.1×

Focus: Normal/AF Macro/Manual focus
Face detection/Multi-area-focusing/1-area-focusing (High speed)/1-area-focusing/Spot-focusing/AF Tracking

Focus range: AF: 30 cm (Wide)/2 m (Tele) to ∞
AF Macro/MF/Intelligent auto:
1 cm (Wide)/2 m (Tele) to ∞
However, 1 m to ∞ for 11× to 18× zoom
Scene mode: There may be differences in the above settings.

Shutter system: Electronic shutter+Mechanical shutter

Motion picture recording: 1280×720 pixels (30 frames/second, only when using a Card)
848×480 pixels (30 frames/second, only when using a Card)
640×480 pixels (30 frames/second, only when using a Card)
320×240 pixels (30 frames/second, 10 frames/second)
With audio

Burst recording

Burst speed: 2.5 pictures/second (Normal), Approx. 2 pictures/second (Unlimited)

Number of recordable pictures: Max. 5 pictures (Standard), max. 3 pictures (Fine), Depends on the remaining capacity of the built-in memory or the card (Unlimited).
(Performance in burst recording is only with SD Memory Card/SDHC Memory Card. MultiMediaCard performance will be less.)

Hi-speed burst	
Burst speed:	11 pictures/second ([SPEED PRIORITY]: 3M (4:3)) 12 pictures/second ([SPEED PRIORITY]: 2.5M (3:2)) 13 pictures/second ([SPEED PRIORITY]: 2M (16:9)) 7 pictures/second ([IMAGE PRIORITY]: 3M (4:3), 2.5M (3:2) or 2M (16:9))
Number of recordable pictures:	20 to 60 ([SPEED PRIORITY]) 20 to 100 ([IMAGE PRIORITY]) (differs depending on the type of Card and the recording conditions)
ISO sensitivity:	AUTO/100/200/400/800/1600 [HIGH SENS.] mode: 1600 to 6400
Shutter speed:	60 seconds to 1/2000th of a second [STARRY SKY] mode: 15 seconds, 30 seconds, 60 seconds
White balance:	Auto white balance/Daylight/Cloudy/Shade/Flash/Incandescent lights/White set1/White set2/White balance K set
Exposure (AE):	Programme AE (P)/Aperture-priority AE (A)/Shutter-priority AE (S)/Manual exposure (M) Exposure compensation (1/3 EV Step, -2 EV to +2 EV)
Metering mode:	Multiple/Centre weighted/Spot
LCD monitor:	2.7" TFT LCD (Approx. 230,000 dots) (field of view ratio about 100%)
Viewfinder:	Colour LCD Viewfinder (Approx. 201,000 pixels) (field of view ratio about 100%) (with diopter adjustment -4 to +4 diopter)
Flash:	Built-in pop up flash Flash range: [ISO AUTO] Approx. 30 cm to 8.5 m (Wide) AUTO, AUTO/Red-eye reduction, Forced flash ON (Forced ON/Red-eye reduction), Slow sync./Red-eye reduction, Forced flash OFF
Microphone:	Monaural
Speaker:	Monaural
Recording media:	Built-in Memory (Approx. 50 MB)/SD Memory Card/SDHC Memory Card/MultiMediaCard (Still pictures only)
Picture size	
Still picture:	When the aspect ratio setting is [4:3] 3648×2736 pixels, 3072×2304 pixels, 2560×1920 pixels, 2048×1536 pixels, 1600×1200 pixels, 640×480 pixels When the aspect ratio setting is [3:2] 3648×2432 pixels, 3072×2048 pixels, 2560×1712 pixels, 2048×1360 pixels When the aspect ratio setting is [16:9] 3648×2056 pixels, 3072×1728 pixels, 2560×1440 pixels, 1920×1080 pixels
Motion pictures:	1280×720 pixels (Only when using a Card) 848×480 pixels (Only when using a Card) 640×480 pixels (Only when using a Card) 320×240 pixels

Quality:	Fine/Standard/RAW/RAW+JPEG
Recording file format	
Still Picture:	JPEG (based on "Design rule for Camera File system", based on "Exif 2.21" standard)/RAW, DPOF corresponding
Pictures with audio:	JPEG (based on "Design rule for Camera File system", based on "Exif 2.21" standard)+"QuickTime" (pictures with audio)
Motion pictures:	"QuickTime Motion JPEG" (motion pictures with audio)
Interface	
Digital:	"USB 2.0" (High Speed)
Analogue video/ audio:	NTSC/PAL Composite (Switched by menu), Component Audio line output (monaural)
Terminal	
[COMPONENT OUT]:	Dedicated jack (10 pin)
[DIGITAL/AV OUT]:	Dedicated jack (8 pin)
[DC IN]:	Type 3 jack
Dimensions:	Approx. 117.6 mm (W)×75.3 mm (H)×88.9 mm (D) (excluding the projecting parts)
Mass:	Approx. 370 g (excluding card and battery) Approx. 417 g (with card and battery)
Operating temperature:	0 °C to 40 °C
Operating humidity:	10% to 80%

Battery Charger (Panasonic DE-A43B):

Information for your safety

Input:	110 V to 240 V ~50/60 Hz, 0.15 A
Output:	CHARGE 8.4 V --- 0.43 A

Equipment mobility: Movable

Battery Pack (lithium-ion) (Panasonic CGR-S006E):

Information for your safety

Voltage:	7.2 V
-----------------	-------

Useful Information

Customer Service

Customer Service Directory

Obtain information products and operative assistant; localize the closer distributor or Service Center; buy spare parts and accessories by our web site to Latin American:

<http://www.lar.panasonic.com>

Also you may contact us directly by our Contact Center:

Panama	800-PANA (800-7262)
Colombia	1-8000-94PANA (1-8000-947262) - National Line 635-PANA (635-7262) - Bogota Line
Ecuador	1800-PANASONIC (1800-726276)
Costa Rica	800-PANA737 (800-7262737)
El Salvador	800-PANA (800-7262)
Guatemala	1-801-811-PANA (1-801-811-7262)
Chile	800-260602 From a cell phone: 245-2520
Venezuela	800-PANA-800 (800-7262-800)
Uruguay	0-800-PANA (0800-7262)

Mexico Service

To obtain information in the Republic of Mexico contact us at:

[email: atencion.clientes@mx.panasonic.com](mailto:atencion.clientes@mx.panasonic.com)

Or you may contact us in the next following phones numbers:

**01800-VIP-PANA (01800-847-7262) - Interior
(55) 5000-1200 - Mexico D.F. and Metropolitan Area**



QuickTime and the QuickTime logo are trademarks or registered trademarks of Apple Inc., used under license therefrom.

Matsushita Electric Industrial Co., Ltd.

Web Site: <http://panasonic.net>